

SOLID STATE ALARM SYSTEMS
X12 • SERIES



BUY ROMAN, THE BEST.

The Roman Series X12 Solid State Annunciator Systems are the most versatile window annunciators on the market. The systems accept a wide variety of inputs such as live or dry contacts, solid-state switches, analog signals such as Thermocouples, RTD's, millivolt or milliampere, externally sourced AC or DC voltages or pulse signals. The inputs, conditioned through modules integral to the system, provide alarm status identification to be displayed on multi-sized conventional windows. The superior mechanical construction and the quality of

workmanship, combined with the most reliable electronic designs, have established the X12 Series as the leader in the field of window annunciation. The X12 Series is the solution, from the very basic to your most complex monitor requirement for the best possible value.

These features are also available in the X16 Series Remote Logic configuration, suitable for split architecture layouts. The X16 Series may interface with window lamp displays, graphics, or individual lamp assemblies without compromise to the flexibility of the input and output features.

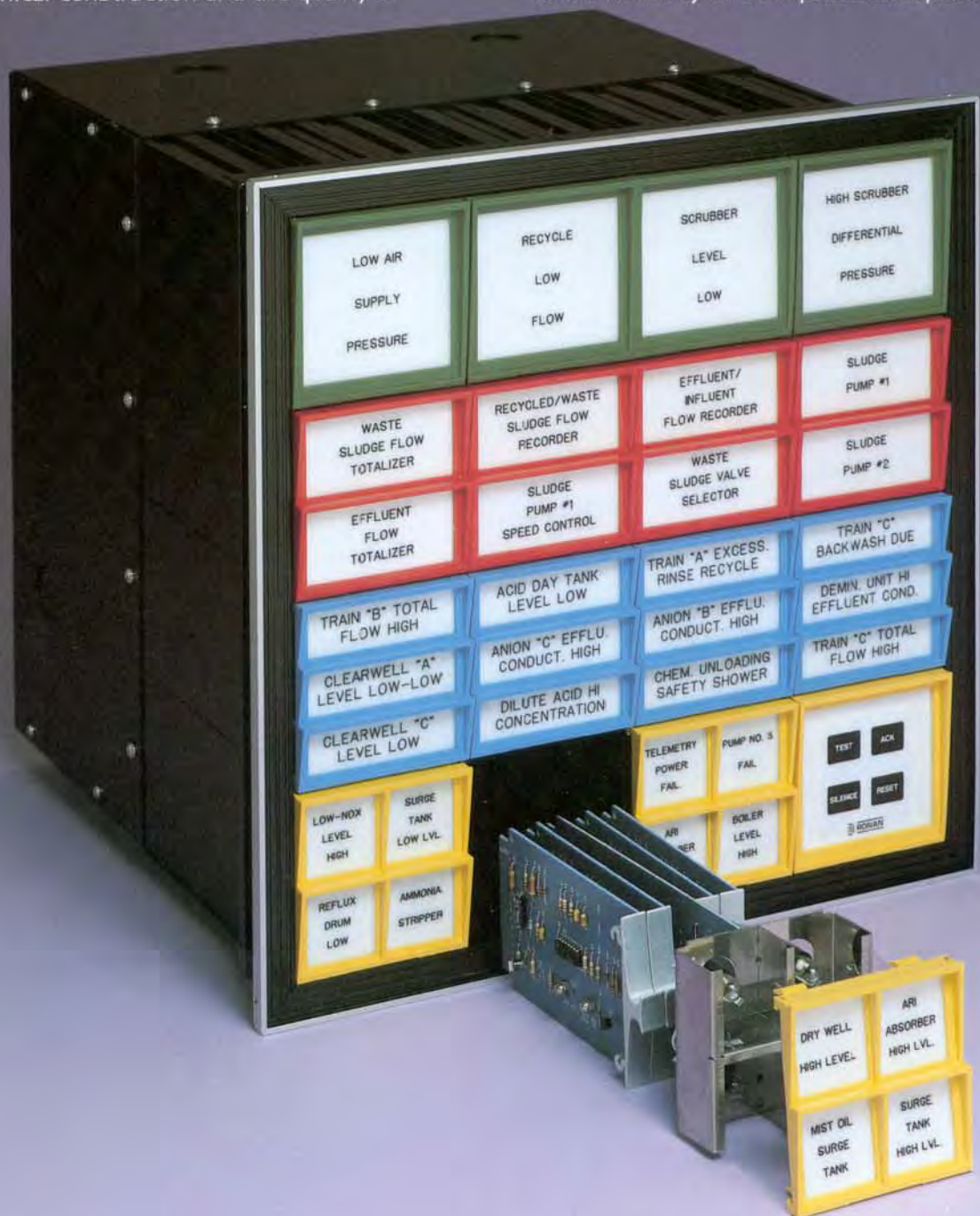

SYSTEM FUNCTIONS

INPUTS

Digital

- Dry Contact — Normally Open/Normally Closed
- Logic Level — Transistor/Silicon Controlled Rectifier/Integrated Circuit
- Voltage — AC/DC, Opto-Isolated

Analog

- Resistance Temperature Devices (RTD) — Cu, Pt, Ni
- Thermocouple (TC) — E, J, K, R, S, T
- Voltage — 0-5 VDC, 1-5 VDC, 0-10 VDC, 0-10 mV, 0-25 mV, 0-50 mV
- Current — 0-1 mA, 4-20 mA, 10-50 mA

Pulse

- Motion Detector

Intrinsically Safe

SEQUENCES

All, per ISA Standard S18.1

Special Custom Designs

Multiple Sequences on a Logic Module

Multiple Sequences in One Chassis

Multiple Input/Refresh

Selectable per Window

OUTPUT FUNCTIONS

Time Delay

Auxiliary Contacts

- Single Pole, Selectable NO/NC
- Double Pole, Selectable NO/NC
- Normally De-Energized
- Normally Energized — Fail Safe
- Follows Field Contact
- Follows Lamp Logic

Common Trouble Alarm (CTA)

Multiple/Selectable Audible

Ground Fault Detection

Loss of Power Alarm

Auxiliary Lamp Drive (Mimic)

FEATURES

Design Technology — CMOS

- High Noise Immunity
- Field Proven
- Available Off-the-Shelf, World-Wide
- No Custom Integrated Circuits

Individual Channel Philosophy

- No Multi-Channel Circuit Functions

- Stand-Alone Alarm Modules — No Shared Circuitry

Expandability

- Up to 300%

Quality Construction

- All Aluminum Extrusions
- Excellent Heatsinking
- Modular Assembly
- Maximum Flexibility in System Sizing
- Easy Panel Mounting
- Rugged Construction

Color Coding

- Eight Bezel Colors
- Color Lenses
- Sandwich Lenses

APPROVALS

CSA — Canadian Standard Association

FM — Factory Mutual

BASEEFA — British Approvals Service for Electrical Equipment in Flammable Atmospheres

UL — Underwriters Laboratory

SERVICES

Custom Designed Systems

Custom Designed Logic

Customer Training

Complete System Documentation

Field Service and Start-Up

WARRANTY

Three (3) Years

FIELD SERVICE

World-Wide Sales and Service Offices

MANUFACTURING

Complete Facilities in:

- USA: Woodland Hills, California
- Canada: Toronto
- United Kingdom: Washington, Tyne and Wear
- Australia: Sydney

CONTENTS

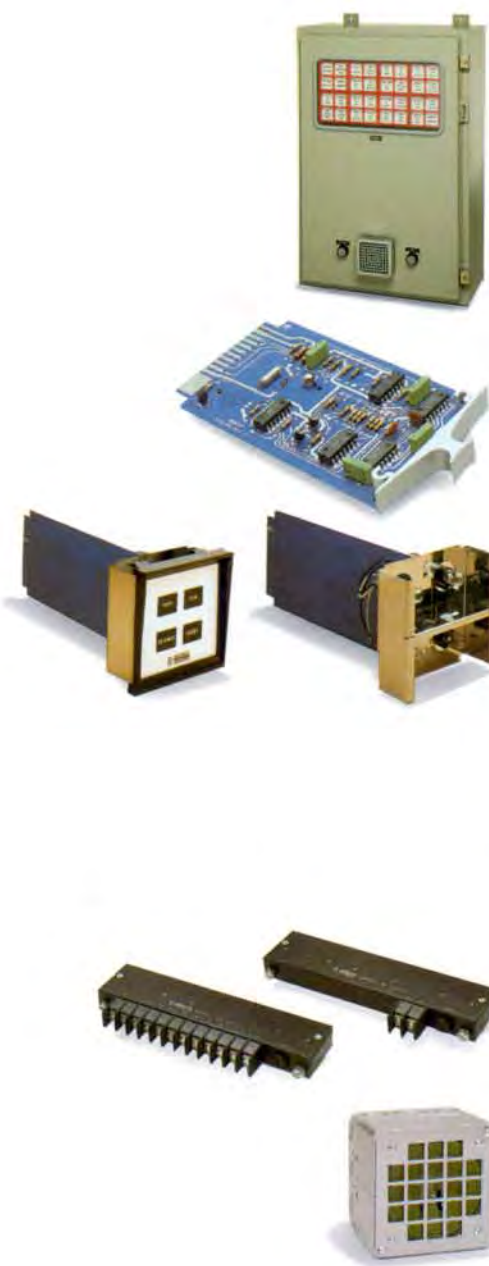

Buy Ronan, The Best	2
System Functions	3
System Enclosures	5
Monalarm Series	6
Binalarm Series	7
Trialarm Series	8
Quadalarm Series	9
Alarm Modules	10
Special Function Modules	12
Sequences	14
Pushbutton/Lamp Modules	16
System Expandability	17
System Color Coding	17
Nameplate Engravings	18
Power Supplies/Inverters	19
General Specifications	19
Special Mounting	21
Terminal Arrangements	20, 22, 23
Systems Support	24
Wiring/Alarm Sequences	25
Wiring/Auxiliary Functions	26
Accessories — Pushbuttons/Horns	27
Ordering Information	28
Typical Ordering Information	31

3-Year Warranty

Ronan warrants equipment of its own manufacture to be free from defects in material and workmanship, under normal conditions of use and service, and will repair or replace any component found to be defective, on its return, transportation charges prepaid, within three years of its original purchase. This warranty carries no liability, either expressed or implied, beyond our obligations to replace the unit which carries the warranty.

Note: Specifications and design subject to change without notice.

SYSTEMS ENCLOSURES

The Ronan enclosures for Annunciators with integral electronics are assembled from basic 3.5 inch (89 mm) by 3.5 inch (89 mm) mechanical modules to overall size requirements specified. This allows the greatest flexibility to adapt to the customer's control panel dimensions. The aluminum

extrusion modules provide excellent heat dissipation for a continuously lit annunciator system and feature structural strength required on industrial applications. The enclosures are painted with a black, baked semigloss enamel; custom colors may be supplied optionally.

The flush-mounting NEMA 1 type enclosure, for control panel applications, feeds through a rectangular cutout and attaches to the panel with a number of simple clamping devices supplied with each system. The rear accessible terminals are enclosed within protective side and rear panels. The side panels feature pre-stamped conduit knockout entries for field wiring and power input.



For applications requiring wall mounted annunciators, Ronan provides NEMA 4 and NEMA 12 front accessible enclosures. The integral surface mounted annunciator is available for use in General Purpose or Class I, Division 2 Hazardous Location. The Monalarm, Binalarm, Trialarm and/or Quadalarm displays show through a shatter-proof glass window and the pushbuttons and horn are mounted on the hinged door. All plug-in modules and field terminals are front accessible for installation and ease of service. The cabinet finish is gray, baked semigloss enamel.



The panel mount enclosure may be enhanced with a NEMA 4 or NEMA 12 door assembly to seal the front of the alarm system against the control panel where it is subject to moisture or a corrosive atmosphere. The door is a

clear acrylic window, sealed with a neoprene gasket. Gasketing is supplied for sealing between door frame and control panel.

Note: The panel cutout is the same as specified in the standard flush-mounted alarm systems.

The Ronan alarm systems of various window sizes are available for standard 19 inch (483 mm) or 24 inch (610 mm) relay rack mounting. The five mechanical modules wide unit is suitable for 19 inch (483 mm), and the six modules wide unit for 24 inch (610 mm) rack spacing.



Series X165M
Surface Mounted



Series X16RR
Relay Rack
Mounted



For applications where remote mounted alarm indicators such as Lamp Cabinets, Graphics, Bull's-eye or other Lamp Displays are used, the logic modules are housed in rack or surface mounted enclosures. Multiconductor cables or custom wiring provide connection between logic and display.

MONALARM SERIES

Model X12-1000

Flushmounting Type for Control Panels

Nameplate Size 2.75" (70 mm) × 3.00" (76 mm)

These systems are expandable and intermixable.

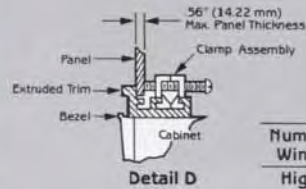
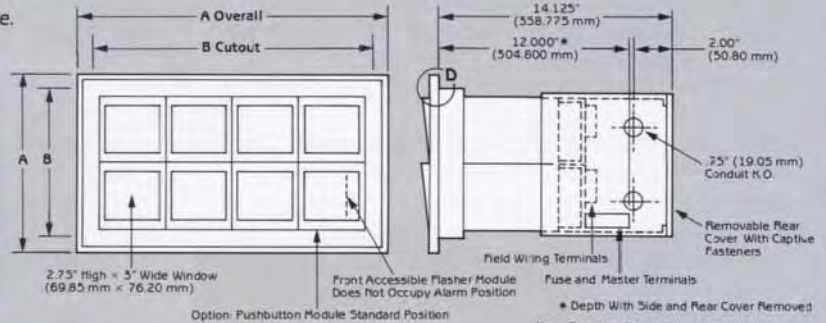

Number of Windows High or Wide	A Overall		B Cutout	
	In.	mm	In.	mm
1	5.00	127.0	4.38	111.3
2	8.50	215.9	7.88	200.2
3	12.00	304.8	11.38	289.1
4	15.50	393.7	14.88	378.0
5	19.00	482.6	18.38	466.9
6	22.50	571.5	21.88	555.8
7	26.00	660.4	25.38	644.7
8	29.50	749.3	28.88	733.6
9	33.00	838.2	32.38	822.5
10	36.50	927.1	35.88	911.4
11	40.00	1016.0	39.38	1000.3
12*	43.50	1104.9	42.88	1089.2

*Not limited to 12 high or wide.

*The integral Pushbutton Station shown is available as an option and will occupy the position as shown. Pushbutton Stations will operate in conjunction with externally wired pushbuttons. The lower, right hand position also houses the Flasher/Horn Driver Module.

Model X12RR-1000

Relay Rack Mounting Type

19 Inch (483 mm) Rack Mounting – Standard
 24 Inch (610 mm) Rack Mounting – Optional

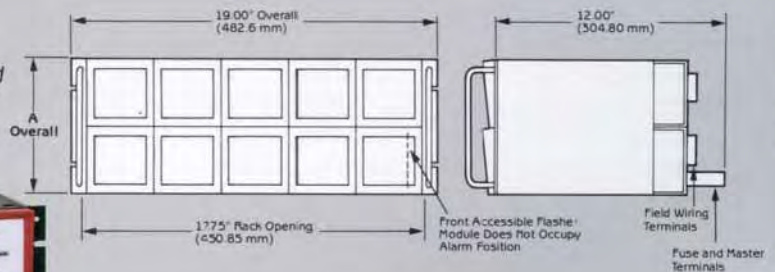

Number of Windows	A Overall			
	High	Wide	In.	mm
1	5"	3.5	88.9	
2	5	7.0	177.8	
3	5	10.5	266.7	
4*	5	14.0	355.6	

*Not limited to 4 high

**Limited to 5 wide only (19 inch, 483mm rack)
 Also available 6 wide (24 inch, 610 mm rack)

BINALARM SERIES

Model X12-2000

Flush Mounting Type for Control Panels

Nameplate Size 1.44" (36 mm) × 3.00" (76 mm)

These systems are expandable and intermixable.

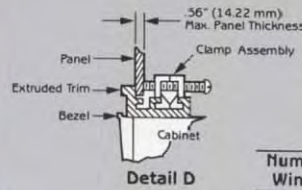
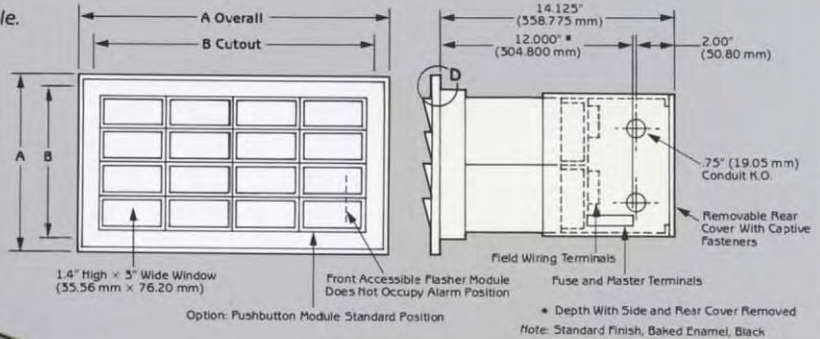

Number of Windows		A Overall		B Cutout	
High	Wide	In.	mm	In.	mm
2	1	5.00	127.0	4.38	111.3
4	2	8.50	215.9	7.88	200.2
6	3	12.00	304.8	11.38	289.1
8	4	15.50	393.7	14.88	378.0
10	5	19.00	482.6	18.38	466.9
12	6	22.50	571.5	21.88	555.8
14	7	26.00	660.4	25.38	644.7
16	8	29.50	749.3	28.88	733.6
18	9	33.00	838.2	32.50	825.5
20	10	36.50	927.1	36.00	914.4
22	11	40.00	1016.0	39.50	1003.3
24*	12*	43.50	1104.9	43.00	1092.2

*Not limited to 24 high or 12 wide.

*The integral Pushbutton Station shown is available as an option and will occupy the position as shown. Pushbutton Stations will operate in conjunction with externally wired pushbuttons. The lower right hand position also houses the Flasher/Horn Driver Module.

Model X12RR-2000

Relay Rack Mounting Type

19 Inch (483 mm) Rack Mounting – Standard

24 Inch (610 mm) Rack Mounting – Optional

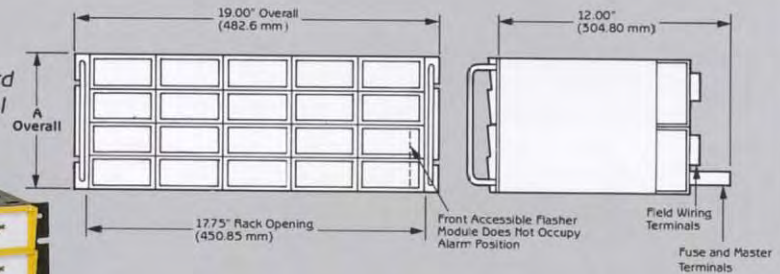

Number of Windows		A Overall	
High	Wide	In.	mm
2	5**	5.5	88.9
4	5	7.0	177.8
6	5	10.5	266.7
8*	5	14.0	355.6

*Not limited to 8 high

**Limited to 5 wide only (19 inch, 483 mm rack)

Also available 6 wide (24 inch, 610 mm rack)

TRIALARM SERIES

Model X12-3000

Flush Mounting Type for Control Panels

Nameplate Size .86" (22 mm) × 3.00" (76 mm)

These systems are expandable and intermixable.

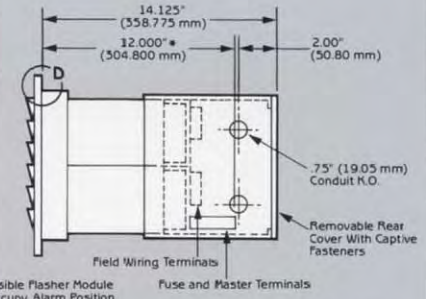
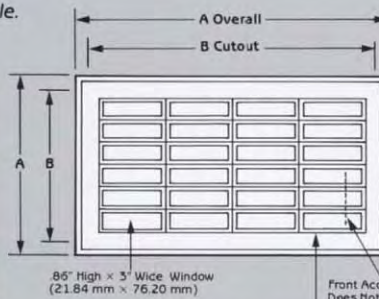

Option: Pushbutton Module Standard Position

* Depth With Side and Rear Cover Removed
Note: Standard Finish, Baked Enamel, Black

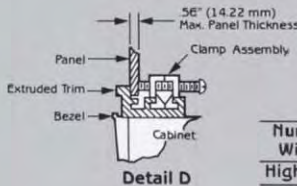
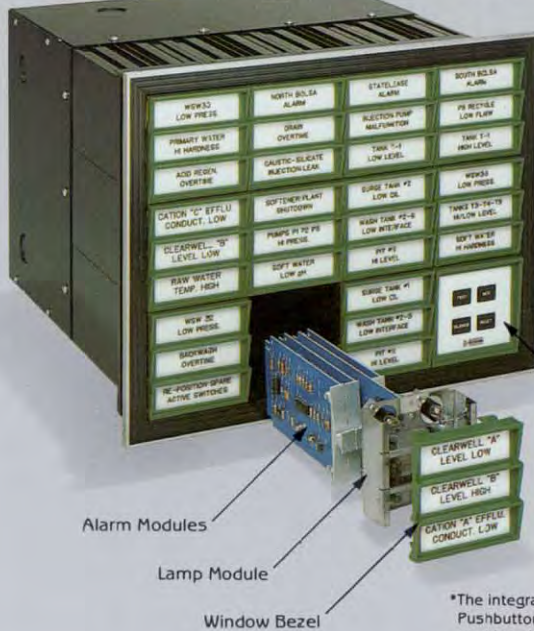

*Pushbutton Stations

Number of Windows	High	Wide	A Overall		B Cutout	
			In.	mm	In.	mm
3	1	5.00	127.0	4.38	111.3	
6	2	8.50	215.9	7.88	200.2	
9	3	12.00	304.8	11.38	289.1	
12	4	15.50	395.7	14.88	378.0	
15	5	19.00	482.6	18.38	466.9	
18	6	22.50	571.5	21.88	555.8	
21	7	26.00	660.4	25.38	644.7	
24	8	29.50	749.3	28.88	733.6	
27	9	33.00	838.2	32.50	825.5	
30	10	36.50	927.1	36.00	914.4	
33	11	40.00	1016.0	39.50	1003.3	
36*	12*	43.50	1104.9	43.00	1092.2	

*Not limited to 36 high or 12 wide.

*The integral Pushbutton Station shown is available as an option and will occupy the position as shown. Pushbutton Stations will operate in conjunction with externally wired pushbuttons. The lower, right hand position also houses the Flasher/Horn Driver Module.

Model X12RR-3000

Relay Rack Mounting Type

19 Inch (483 mm) Rack Mounting – Standard

24 Inch (610 mm) Rack Mounting – Optional

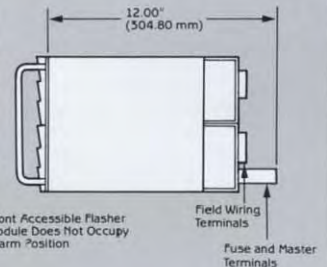
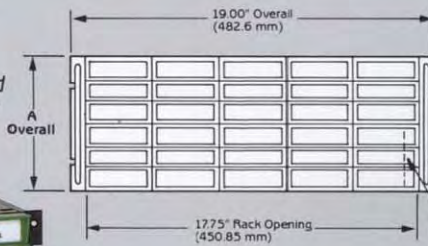

Front Accessible Flasher Module Does Not Occupy Alarm Position

Number of Windows	High	Wide	A Overall	
			In.	mm
3	5**	3.5	88.9	
6	5	7.0	177.8	
9	5	10.5	266.7	
12*	5	14.0	355.6	

*Not limited to 12 high.

**Limited to 5 wide only (19 inch, 483 mm rack)
Also available 6 wide (24 inch, 610 mm rack)

QUADALARM SERIES

Model X12-4000

Flush Mounting Type for Control Panels

Nameplate Size 1.44" (36 mm) × 1.44" (36 mm)

These systems are intermixable.

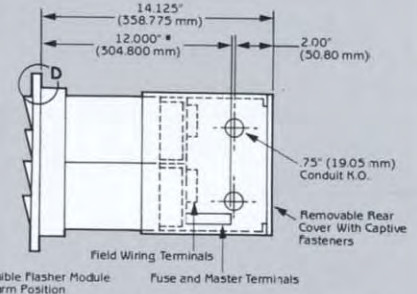
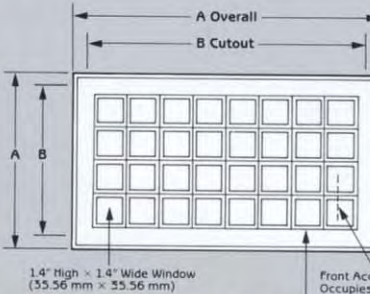

Option: Pushbutton Module Standard Position

* Depth With Side and Rear Cover Removed
Note: Standard Finish, Baked Enamel, Black

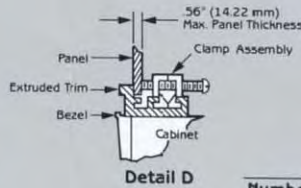
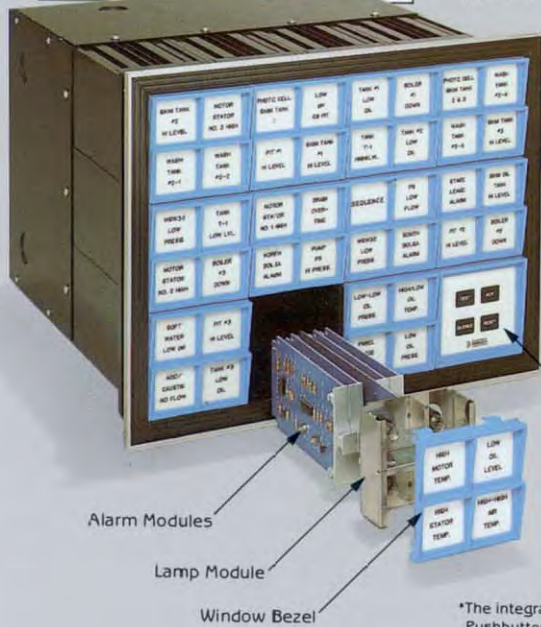

*Pushbutton Stations

Number of Windows High or Wide	A Overall		B Cutout	
	In.	mm	In.	mm
2	5.00	127.0	4.38	111.3
4	8.50	215.9	7.88	200.2
6	12.00	304.8	11.38	289.1
8	15.50	393.7	14.88	378.0
10	19.00	482.6	18.38	466.9
12	22.50	571.5	21.88	555.8
14	26.00	660.4	25.38	644.7
16*	29.50	749.3	28.88	733.6

*Not limited to 16 high or wide.

*The integral Pushbutton Station shown is available as an option and will occupy the position as shown. Pushbutton Stations will operate in conjunction with externally wired pushbuttons. The lower, right hand position also houses the Flasher/Torn Driver Module.

Model X12RR-4000

Relay Rack Mounting Type

19 Inch (483 mm) Rack Mounting – Standard
24 Inch (610 mm) Rack Mounting – Optional

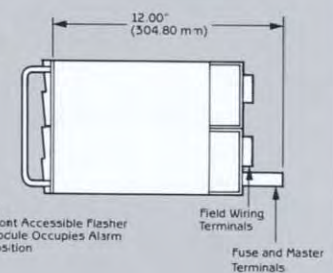
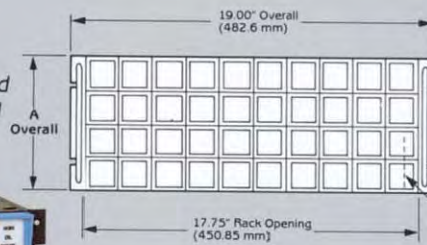

*Not limited to 8 high.

**Limited to 10 wide only (19 inch, 483mm rack)
Limited to 12 wide only (24 inch, 610 mm rack)

Number of Windows High	Wide	A Overall	
		In.	mm
2	10**	3.50	88.9
4	10	7.00	177.8
6	10	10.50	266.7
8*	10	14.00	355.6

ALARM MODULES

The Ronan Series X12 Annunciators may be configured to allow the monitoring of a great variety of input functions by simple selection of the proper signal conditioning/logic modules from the extensive collection available. The availability of these integral Annunciator modules eliminates the requirement for remote mounted signal conditioning modules to convert signals such as analog, frequency, pulse, etc. to contact inputs for the Ronan System. Now, one module can provide functions

such as thermocouple, RTD or engineering input conditioning; reference junction compensation; input curve linearization; trip point setting; choice of alarm sequences; output contacts for computer, sequence of events recorder or shutdown circuitries; analog outputs totally isolated from the system's input for control purposes, etc. The special function modules, systems integrally mounted in the system, may optionally be provided for interface requirements not related to the alarm system.

Alarm Sequence Module

The Alarm Sequence Modules, designed with proven state of the art CMOS circuit technology with low power consumption and high noise immunity, are available in all ISA-518.1 Standard Sequences, as well as a great number of industry standard and Ronan exclusive sequences (see page 28). The Sequence Modules accept dry field contact inputs, interrogated with either 24 VDC or 125 VDC supplied normally by the annunciator system's power supply. If your sequence requirements are unique, Ronan's Engineering Staff can utilize our proven circuit designs as a base to provide a reliable custom design for the application.

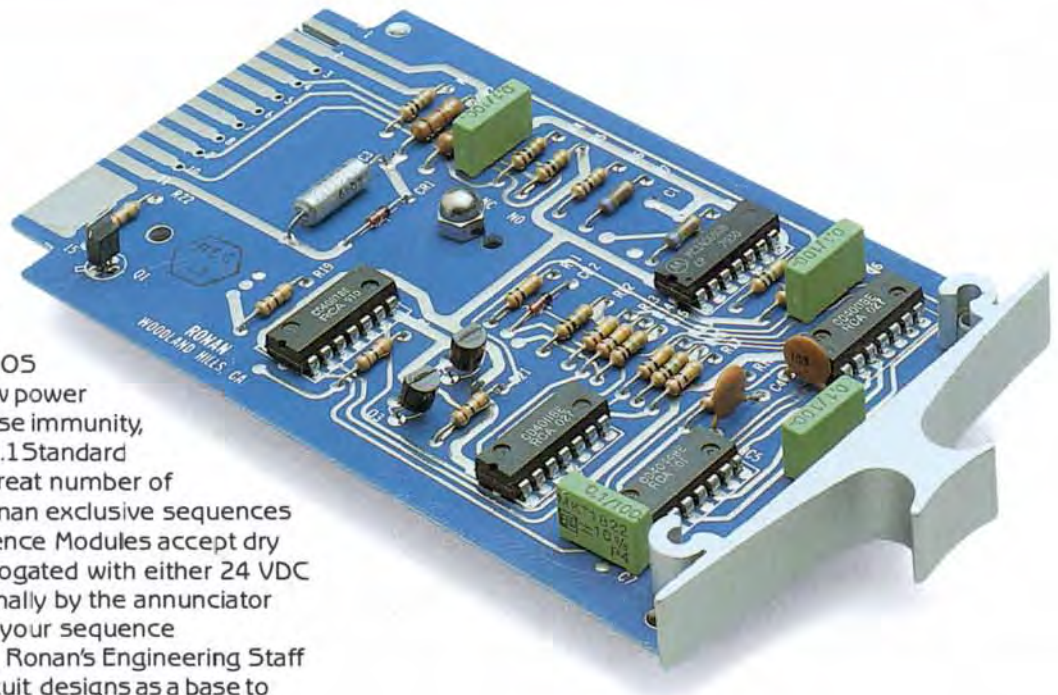

Options

The standard alarm sequence modules may be combined with a great number of special functions incorporated into a single logic module as shown below. By combining the various options shown, the individual module becomes uniquely customized to your specific requirement. For input variations choose from standard contact, analog interface for voltage or current loops, thermocouples or RTD's with input isolation such as opto-coupling or transformer isolation and with or without time delay. For output functions choose Common Trouble Alarm, auxiliary relay contacts, opto-isolated outputs and mimic lamp drivers with or without short circuit proof capability. Whatever your requirements, the

Ronan X12 Series alarm logic modules provide the proven high quality performance solution to your requirement.

1. Optical Isolation – Optically coupled input circuitry is available for applications requiring total isolation from outside voltage sources. Thus, existing shared field contacts with interrogation voltages of 5 to 240 VAC or DC may be interfaced with our alarm systems, providing 2500 volt isolation, with highest reliability, without interference with the existing systems. This option is available in the ranges of 10 to 30 volts, 40 to 140 volts and 180 to 250 volts.

ALARM MODULES

2. Time Delay — The alarm sequence modules are available with either fixed, preset or adjustable time delay for acceptance of the field contact status transfer. The delays to be specified, in ranges from 10 msec to 30 minutes, are adjustable in the field by means of a precision 20-turn potentiometer for highly accurate time setting. The time delay circuits utilize CMOS oscillator, counter techniques for maximum repeatability and ease of setting.



3. Analog Inputs — The fully isolated analog trip circuit, provided on the same logic card as the alarm circuitry, allows direct connection of analog inputs to the window annunciator. You may order alarm modules which interface to 10, 100 or 120 ohm RTD's, all types of thermocouples, and 4-20 mA, 10-50 mA or 1-5 volts, etc., with no extraneous wiring or additional equipment. Where required, the analog circuitry provides total isolation from the 24 VDC system's supply voltage and the sensor input such as thermocouples, etc. The analog circuit utilizes multi-turn precision potentiometers for setpoint and hysteresis and LED indication for ease of setting when the lamp display module is removed from the system.



4. Common Alarm Output — The logic modules may be specified with a common trouble alarm output (CTA), where any one point in the system going into alarm will energize a system relay, optionally installed within the system, or externally provided. This output is generally used to indicate the existence of an alarm condition in a remote annunciator on a window in the main control room annunciator.

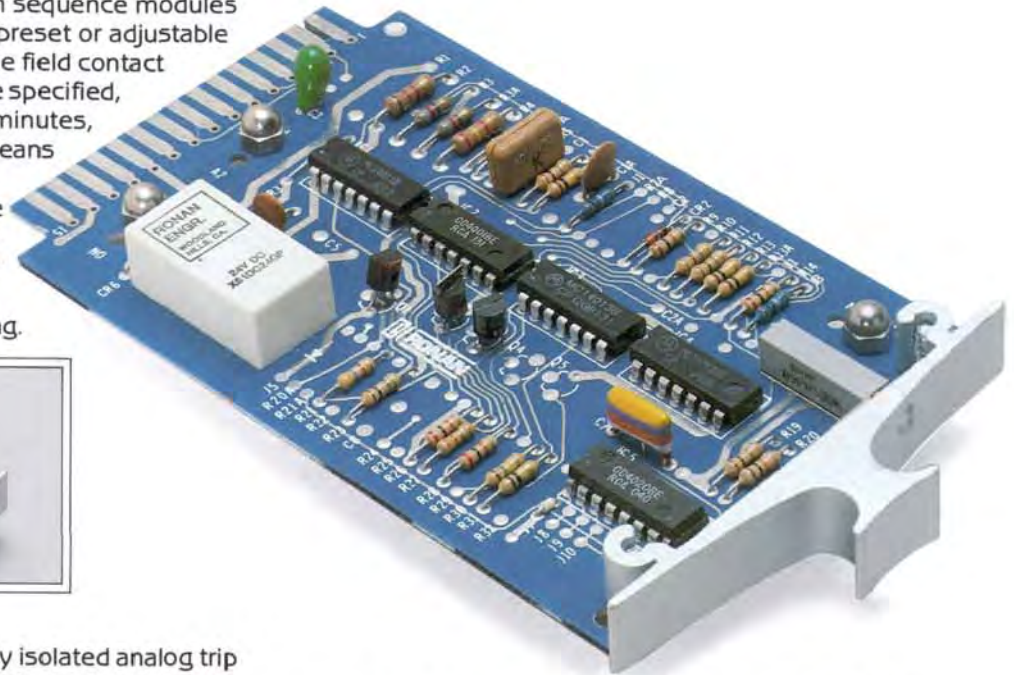

5. Auxiliary Contact — Auxiliary contacts from either general purpose (GP) or hermetically sealed (HS) relays, meeting Class I Division 2 requirements, may be specified as on-board options to the standard logic modules. Each relay contact output is selectable, Form "A" (normally open), or Form "B" (normally closed), and is available either as Normally De-Energized (NDE) (standard) or Normally Energized (NE) (specify at time of order). The auxiliary contacts are used typically for shutdown, repeating of alarms or critical alarm application and may be provided to follow the field contact explicitly, or follow the alarm logic function, where, if the lamps are illuminated, the contact is in the abnormal state.



6. Dual Horn — The alarm logic may be specified to allow selective actuation of two different audible devices. The selection is made by means of a selector switch located on each alarm module. Typical applications are low/high priority, alarm/shutdown, or critical/non-critical alarm indications.

7. Mimic Output — The mimic option provides an output in parallel with the integral window display which drives external lamp indicators, graphic displays, etc. The output drive capability is 6 watts, switching to the minus voltage bus of the system's power supply. Current for the external lamps may be provided by the annunciator power supply or from a remote source.

SPECIAL FUNCTION MODULES

For applications with special input/output requirements directly related to the window annunciator, or for non-related remote functions, these special modules may be mounted integral

to the system. This will greatly reduce the external wiring and remote mechanical housing needs and provide a completely tested, functional system, avoiding costly interface problems.

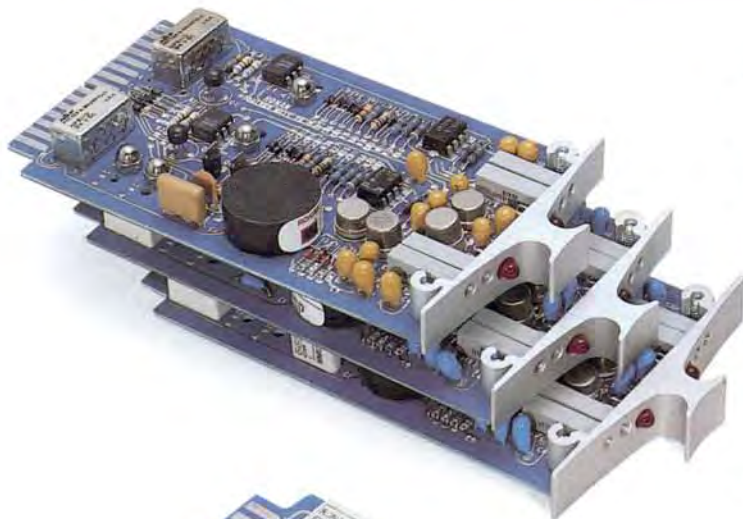

Analog Trip Modules

The Series X50 Analog Trip Modules are available in single or dual setpoint and dual input, single setpoint configurations. The modules provide continuous monitoring of current loop connections, voltage and temperature inputs from RTD's or thermocouples, which are compared against the setpoint, settable by means of precision multi-turn potentiometers. In addition, each module contains hysteresis (dead band) adjust and LED trip indication for each setpoint to allow calibration. If the setpoint is reached, an auxiliary contact and an opto-isolated transistor switch output are activated. All modules provide isolation from the 24 VDC supply voltage for channel integrity via a DC to DC inverter.

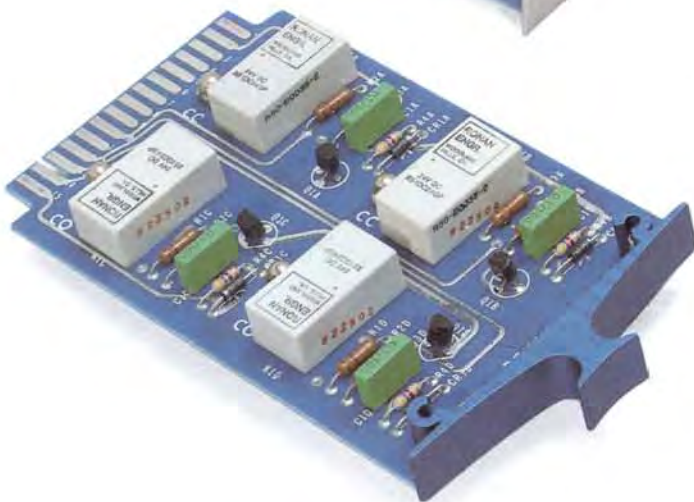

Auxiliary Contact Modules

The auxiliary contact modules provide independent single or multiple auxiliary contact outputs following the field contact status without consideration of alarm logic status. Each input circuit will accept either 24 VDC or 125 VDC, operating either a general purpose or hermetically sealed relay approved for Class I Division 2 areas. The contact is selectable Form "A" (normally open), or Form "B" (normally closed).

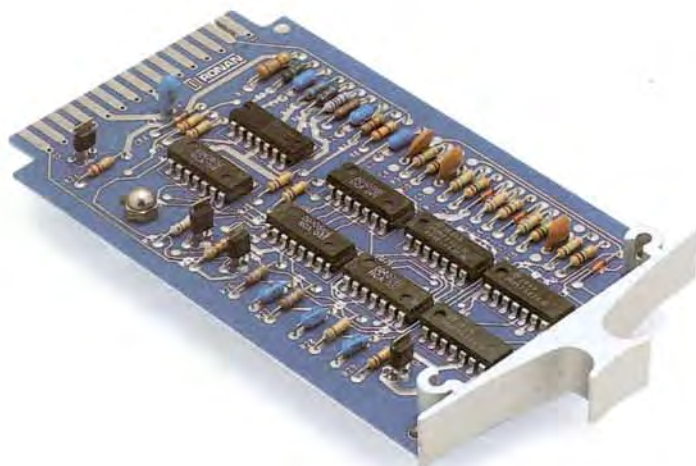

Line Supervisory Module

The Supervisory Module SUPR-800A continuously monitors the status of a process contact and its wiring integrity. The module is designed to distinguish between five possible conditions — Field Contact Normal; Alarm; Open Wiring; Shorted Wiring; and Grounded Wiring. These conditions are annunciated on the associated window by different flash rates and steady light. Typical applications are Entry Protection, Fire Alarms and Critical Process Monitoring Systems, providing, in many cases, insurance cost savings of great significance. The system has Factory Mutual  Approval.

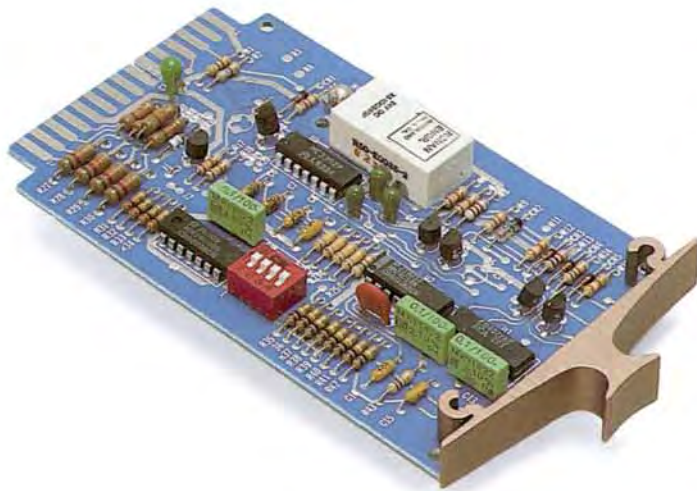

Reflash Module

The Reflash Module, RFL-4, is a multi-contact input monitor, capable to display the alarm condition of a number of inputs on a single window. The Reflash Module recognizes each contact individually and provides a new alarm alert, whenever one of the input contacts enters an abnormal state. Each Reflash Module accepts up to four normally open or normally closed contacts and may be linked with other modules into a group of up to 100 inputs by simple jumper connections on rear panel mounted terminals. The standard module's auxiliary contact output is utilized as the field contact input to the window alarm logic module. An additional open collector transistor output may be provided to actuate the alarm logic, allowing the use of the dry auxiliary contact output for remote annunciation. To allow the alarm window to return to normal, all input contacts assigned to the group are required to return to their normal state.

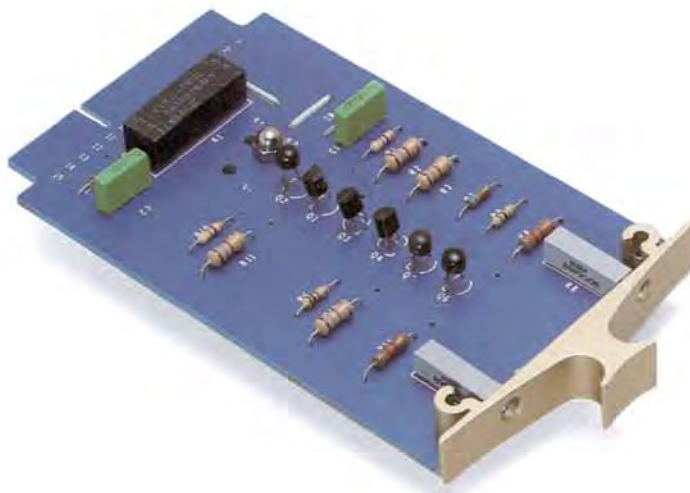

Ground Fault Detector Module

The Ronan Alarm Systems and their power supplies are isolated from ground, allowing the use of a Ground Fault Detection Module to sense field wiring faults. The Ground Fault Detectors are available for both 24 VDC and 125 VDC field contact voltage sensing. If the impedance measured to the system's ground is lower than the fixed or adjustable preset value of 10,000 ohms to 100,000 ohms, a dry contact output transfer may be used to annunciate on a window, or feed an external monitoring instrument.

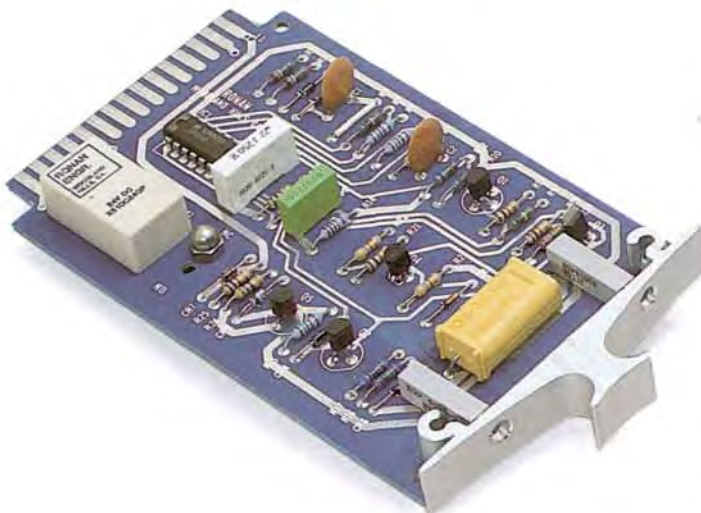

Motion Detector Module

For loss of motion detection in applications such as conveyor belts, vibrating screens, bucket elevators, etc., the Motion Detector Module mounted integral to the alarm system is used to indicate alarm condition, or the shutdown of the process. The module derives its input from the remote, eddy current type sensor head, detecting the loss of motion in critical vibration, or rotating equipment applications. The detector, typically located up to 500 feet from the annunciator, provides pulse inputs to the module where circuitry utilizes multi-turn precision potentiometers to set sensitivity and adjust time delay for recognition of an off-normal condition.

SEQUENCE

Sequence A, Automatic Reset (Ronan ID AS)

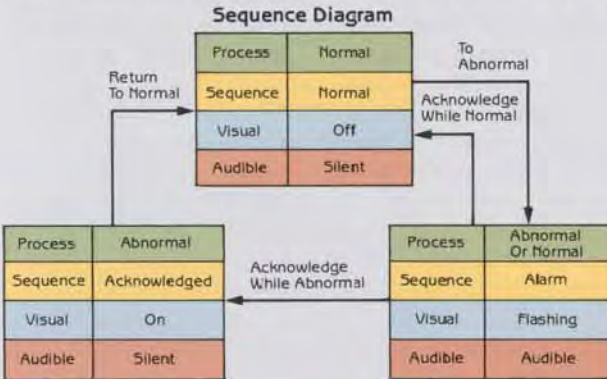

Sequence Features

1. Acknowledge and Test Pushbuttons.
2. Alarm Audible Device.
3. Lock-In of Momentary Alarms Until Acknowledged.
4. The Audible Device Is Silenced and Flashing Stops When Acknowledged.
5. Automatic Reset of Acknowledged Alarm Indications When Process Conditions Return to Normal.
6. Operational Test.

Sequence F2M-1, Manual Reset First Out with No Subsequent Alarm Flashing and Silence Pushbutton (Ronan ID FSMH)

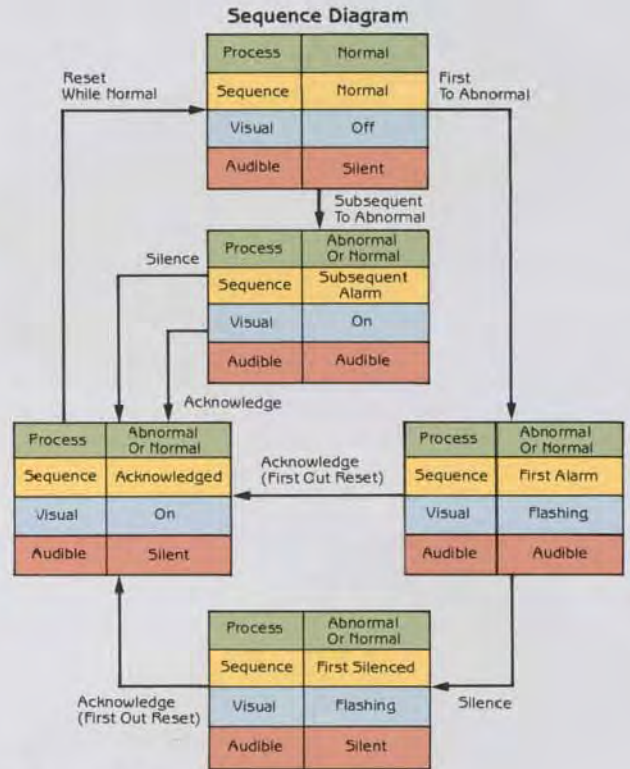

Sequence Features

1. Silence, Acknowledge, Reset and Test Pushbuttons.
2. Alarm Audible Device.
3. Lock-In of Momentary Alarms Until Acknowledged.
4. Option 1: Silence Pushbutton to Silence the Alarm Audible Device While Retaining First Out Flashing Indication.
5. Flashing Indication for First Alarm Only. New Subsequent Alarms Have the Same Visual Indication as Acknowledged Alarms.
6. First Out Indication Is Reset When Acknowledged.
7. Manual Reset of Acknowledged Alarm Indications After Process Conditions Return to Normal.
8. Operational Test.

Sequence F2A, Automatic Reset First Out with No Subsequent Alarm State (Ronan ID FS)

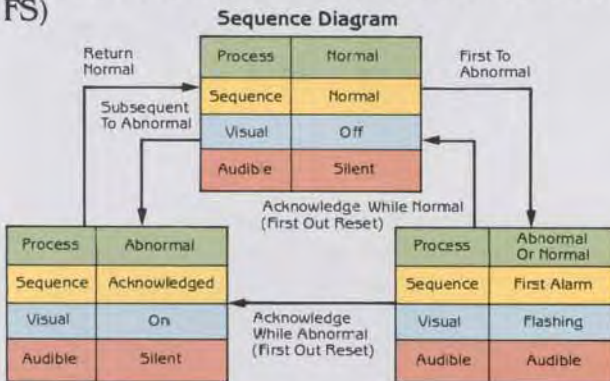

Sequence Features

1. Acknowledge and Test Pushbuttons.
2. Alarm Audible Device.
3. Lock-In Momentary First Alarm Until Acknowledged. No Lock-In of Momentary Subsequent Alarms.
4. Flashing and Audible Indications for First Alarm Only. New Subsequent Alarms Go to the Acknowledged State.
5. First Out Indication Is Reset and the Audible Device Is Silenced When Acknowledged.
6. Automatic Reset of Acknowledged Alarm Indications When Process Conditions Return to Normal.
7. Operational Test.

Typical Method of Specifying Alarm Sequences with Options Using ISA Standard Nomenclature

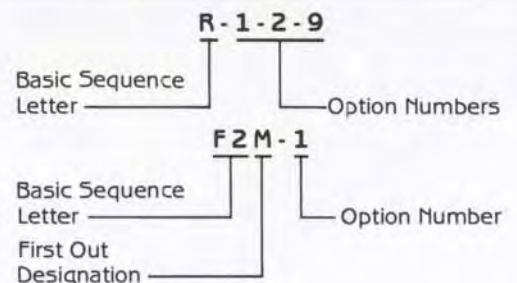

Sequence F3A, Automatic Reset First Out with First Out Flashing and Reset Pushbutton (Ronan ID F3A)

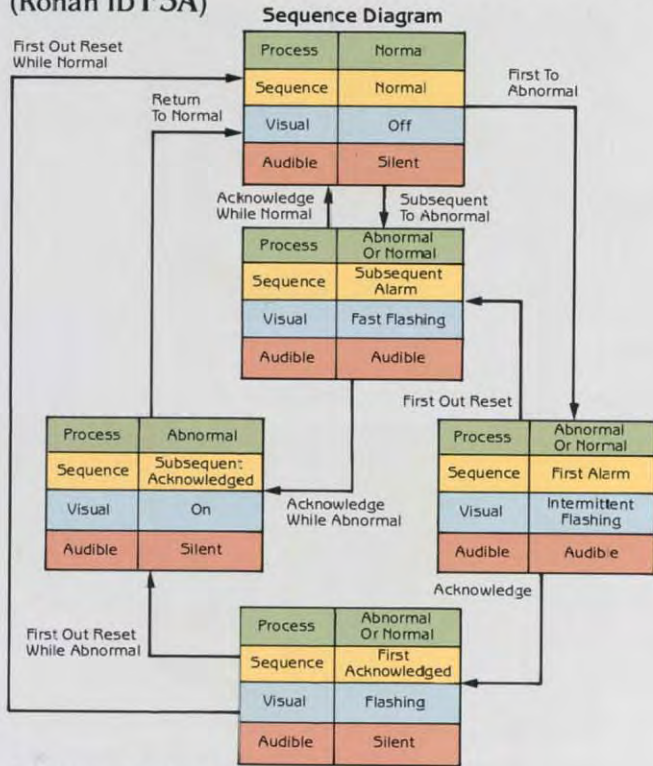

Sequence Features

1. Acknowledge First Out Reset and Test Pushbuttons.
2. Alarm Audible Device.
3. Lock-In of Momentary Alarms Until Acknowledged.
4. First Out Flashing Different from Subsequent Flashing.
5. First Out Reset Pushbutton to Change the First Out Visual Indication to Be the Same as Subsequent Visual Indications.
6. Automatic Reset of Acknowledged Alarm Indications When Process Conditions Return to Normal.
7. Operational Test.

Basic Sequence Letter	Key Words	Option Number	Key Words
A	Automatic Reset	1	Silence Pushbutton
M	Manual Reset	2	Silence Interlock
R	Ringback	3	First Out Reset Interlock
		4	No Lock-In
		5	No Flashing
		6	No Audible
		7	Automatic Alarm Silence
		8	Common Ringback Audible
		9	Automatic Ringback Silence
First Out Designation	Key Words	Option Number	Key Words
F1	No Subsequent Alarm State	10	No Ringback Audible
F2	No Subsequent Alarm Flashing	11	Common Ringback Visual
F3	First Out Flashing and Reset Pushbutton	12	Automatic Momentary Ringback
		13	Dim Lamp Monitor
		14	Lamp Test

Sequence M, Manual Reset (Ronan ID AM)

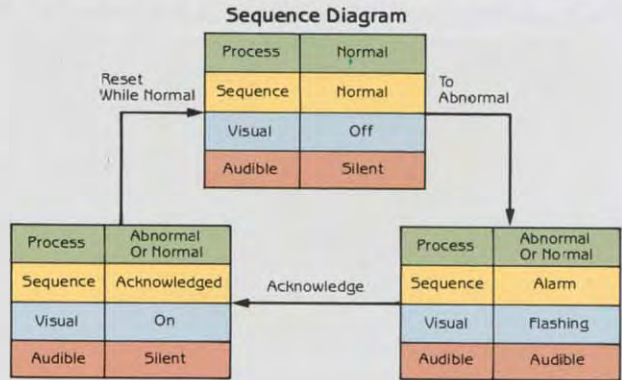

Sequence Features

1. Acknowledge, Reset and Test Pushbuttons.
2. Alarm Audible Device.
3. Lock-In Momentary Alarms Until Acknowledged.
4. The Audible Device Is Silenced and Flashing Stops When Acknowledged.
5. Manual Reset of Acknowledged Alarm Indications After Process Conditions Return to Normal.
6. Operational Test.

Sequence R, Ringback (Ronan ID RD)

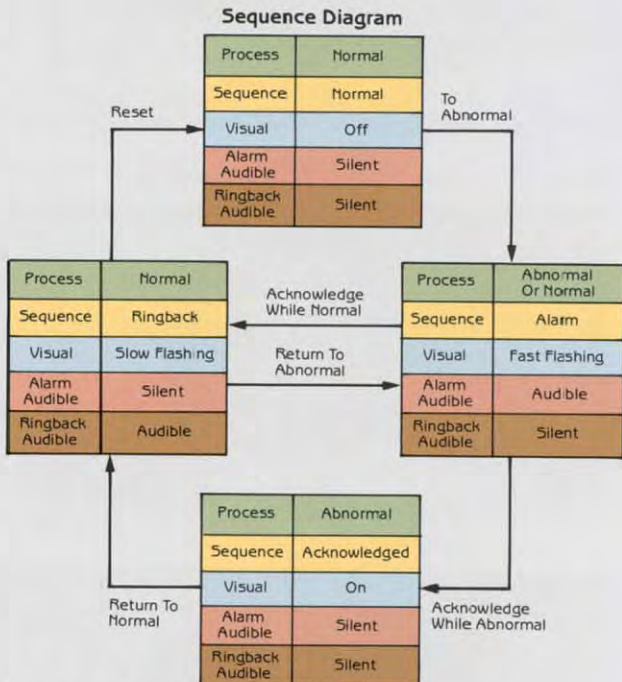

Sequence Features

1. Acknowledge, Reset and Test Pushbuttons.
2. Alarm and Ringback Audible Devices.
3. Lock-In of Momentary Alarms Until Acknowledged.
4. The Audible Device Is Silenced and Fast Flashing Stops When Acknowledged.
5. Ringback Visual and Audible Indications When Process Conditions Return to Normal.
6. Manual Reset of Ringback Indications.
7. Operational Test.

Plug-In Lamp Modules All models are available with incandescent or LED type lamps. See Page 31 to specify.



Alarm Series X12-1000

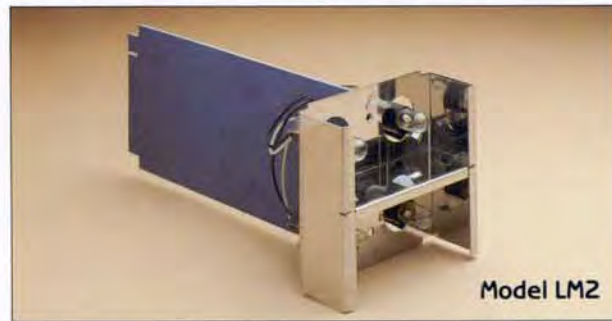

Alarm Series X12-2000



Alarm Series X12-3000

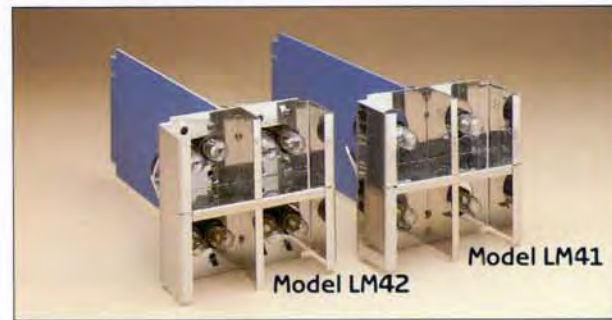

Alarm Series X12-4000

SYSTEM EXPANDABILITY

Series X12-1000, X12-2000 and X12-3000 Alarm Cabinets

The Standard Annunciators, Series 1000, 2000 or 3000, normally not equipped for expansion, may be ordered initially for expansion by adding the suffix "E" in front of desired maximum size identifier. The code 8.10X12-1000-E3000 calls for an eight (8) window high by ten (10) window wide Monalarm Series in which each original window may be field expanded to three (3) windows, thus effecting a three-fold increase in available alarm windows. To allow this future expansion, each physical module is equipped and wired to accommodate the additional alarm modules up to the specified expandability.

The above specified system can be custom expanded to twice as many windows by removing the Bezel (WB1-0) and Lamp Module (LM1), adding one Alarm Module per physical cabinet module, and completing the simple task by insertion of a Binalarm Lamp Module (LM2) and a Binalarm Bezel (WB2-0). If maximum expansion is desired, an additional alarm module, a Trialarm Module (LM3) and a Trialarm Bezel (WB3-0) are required.

The nominal cost addition for the expansion capability makes this feature highly justifiable, if the number of required windows may increase during the life of the alarm system. An allowance will be made on undamaged Lamp Modules and Bezels returned, when converting to the expanded system during the warranty period.

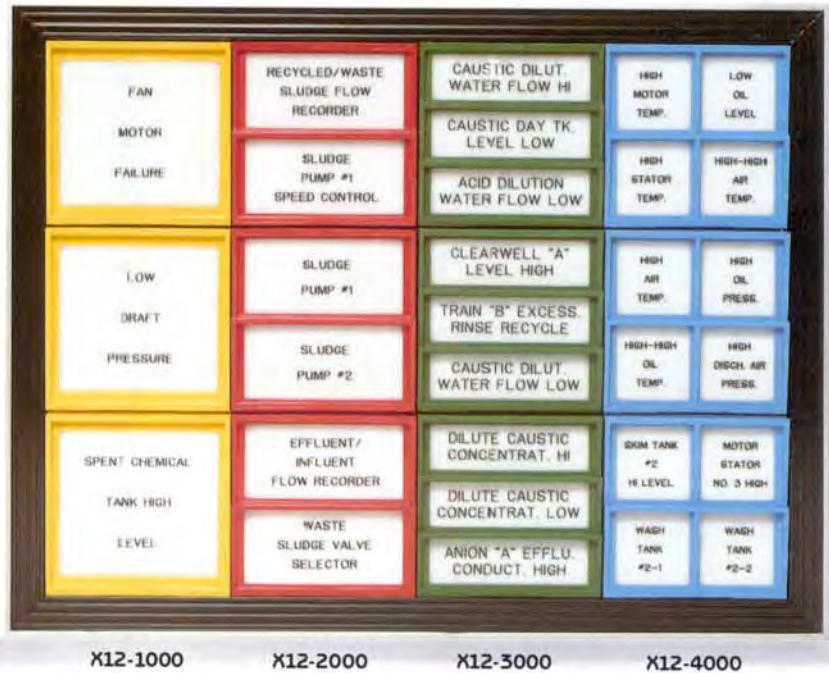

SYSTEM COLOR CODING

Display and Nameplates

Ronan's Window Annunciator may be color coded to designate plant or process function with colored bezels and solid color or sandwich type nameplates.

Bezels

The Bezels are available in eight (8) colors without additional cost, allowing very distinct differentiation between groups of internal system's function, e.g., same sequence, analog or digital inputs, etc., or plant and process groups of similar functions.

Colored Nameplates

The Nameplates may be supplied in five distinct standard colors to identify functions such as fire alarm, shutdown, etc.

Sandwich Nameplates

Sandwich Nameplates, an option exclusive to the Ronan Visual Annunciator, are generally supplied with white front lens and colored rear lens. This lens combination displays all windows white in non-lit status, changing to the selected color in the off-normal lit condition.

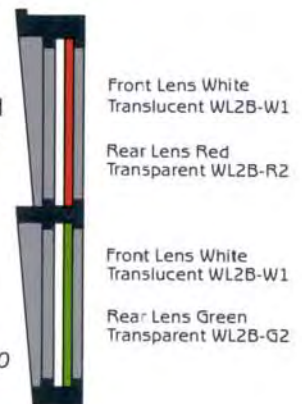

Typical Bezel WB2-0

NAMEPLATE ENGRAVINGS



Monalarm Series 1000 — Model WB1-()*



Binalarm Series 2000 — Model WB2-()*



Trialarm Series 3000 — Model WB3-()*

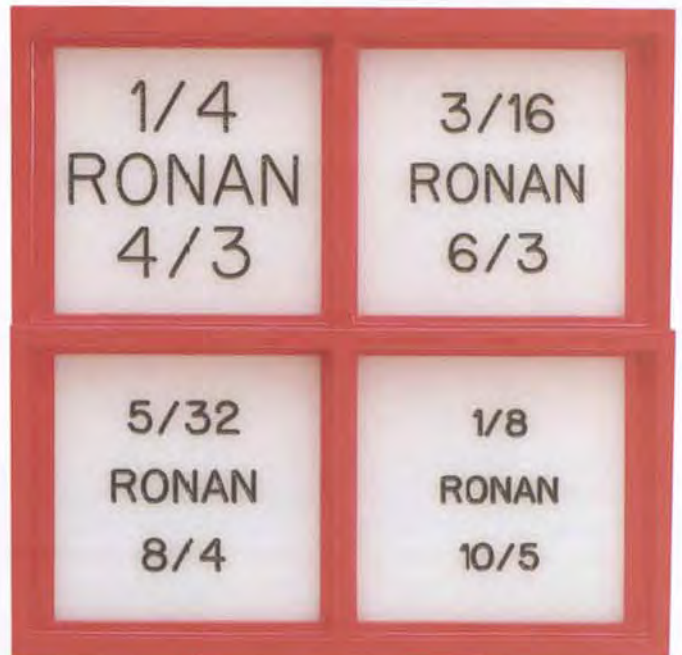

Quadalarm Series 4000 — Model WB4-()*

18

Bezel Colors Available:



*Color Code
Typical Bezel Ordering Information: WB3-(0) (Black Bezel for Trialarm Series)

POWER SUPPLIES/INVERTERS

Your Alarm System may be powered from 115 VAC, 60 Hz; 220 VAC, 50 Hz; 48 VDC or 125 VDC sources by using a power supply or converter generating a nominal 24 VDC unregulated voltage (18-28 VDC) for the logic and lamps, and 24 VDC or 125 VDC for field contact interrogation.

Power Requirement

To specify the correct power supply, count the number of active and future alarm modules you would like to power from the supply. Calculate the total requirement as follows:

Total Watts = Number of Alarm Modules × Factor (F)

F = 6.5 for X12-1000

F = 4.5 for X12-2000 or X12-3000

F = 3.5 for X12-4000

F = .5 plus Remote Lamp Wattage for X16 Series

For auxiliary relays add one (1) watt per point used. Match the total wattage with the next higher power rating of the listed Power Supply or Converter.

AC - DC Power Supplies

115 - 24 - 125
115 - 24 - 250
115 - 24 - 375
115 - 24 - 500
115 - 24 - 750

220 - 24 - 125
220 - 24 - 250
220 - 24 - 375
220 - 24 - 500
220 - 24 - 750

115 - 24/125 - 125
115 - 24/125 - 250
115 - 24/125 - 375
115 - 24/125 - 500
115 - 24/125 - 750

115 - 24 - 250DA
115 - 24 - 375DA
115 - 24 - 500DA
115 - 24 - 750DA

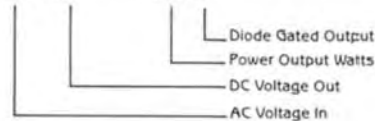

DC - DC Converters

Features: Power Failure Contact Output, Circuit Breaker, Power On Light, Diode Gated Outputs.

125 - 24/125 - 150SCP
125 - 24/125 - 300SCP
125 - 24/125 - 600SCP
48 - 24/125 - 150SCP
48 - 24/125 - 300SCP

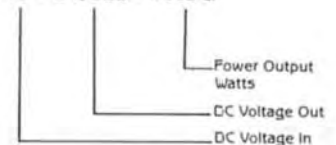

GENERAL SPECIFICATIONS

Systems Voltage:

Logic, Field Contact, Lamps: 24 VDC ±20%

Field Contact: 125 VDC or 48 VDC ±20% Optional

Power Sources:

Systems External Power Supplies or Converters Available for: 120 VAC ±20%, 60 Hz; 240 VAC ±20%, 50/60 Hz; 24, 48 or 125 VDC ±20%

Temperature Range:

Storage: -40° to +85°C (-40° to +185°F)

Operating: -40° to +60°C (-40° to +140°F)

Special High Temperature Systems Available: -40° to +85°C (-40° to +185°F) Operating Temperature

Response Time:

10 msec Nominal. Time Delays Available from 10 msec to 30 min

Controls:

Integral or Remote: Silence, Acknowledge, Reset, Test; Momentary Pushbutton, Single Pole, Normally Open

Inputs:

Contact: Normally Open or Normally Closed. Systems Internal Contact Interrogation Voltage 24 VDC Standard, 48 or 125 VDC Optional
120 VAC. Two Wires, Opto-Isolated

Logic Voltage Open Collector: From Computer, Programmable Controller, Instruments. Specify Type of Interface

Analog Level: Thermocouple, RTD's, 0-1 mA, 40-20 mA, 10-50 mA, 0-5 VDC, 1-5 VDC, 0-10 VDC, 0-10 mV, 0-25 mV, 0-50 mV. For other requirements consult factory.

Outputs:

Light: Fast Flash, Slow Flash, Steady On, Intermittent Fast Flash

Alarm: Single Audible, Selectable Dual Audible, Ringback Audible

Auxiliary Relay: Form "A" or Form "B" Contact Selectable. Standard — Normally De-Energized; Optional — Normally Energized. Rating 2 Amp 28 VDC, 1 Amp 115 VAC

Audible-, Retransmit-, Common Trouble Alarm Relay
Optional: DPDT, Rating 10 Amp 28 VDC, 10 Amp 120 VAC

Systems Size:

Multiple of Cabinet Module: 3.5 in. (89 mm) × 3.5 in. (89 mm). See pages 6 thru 9.

Systems Weight:

Per Cabinet Module: 3.5 lbs. (1.59 kg) Not including Power Supply

Surge Withstand Capability (SWC):

All Logic Tested to: IEEE 472 - 1974 and ANSI/IEEE C37-90 - 1978

TERMINAL ARRANGEMENTS

Rear Terminal Arrangement Panel Mount Type

Standard and First Out Sequence

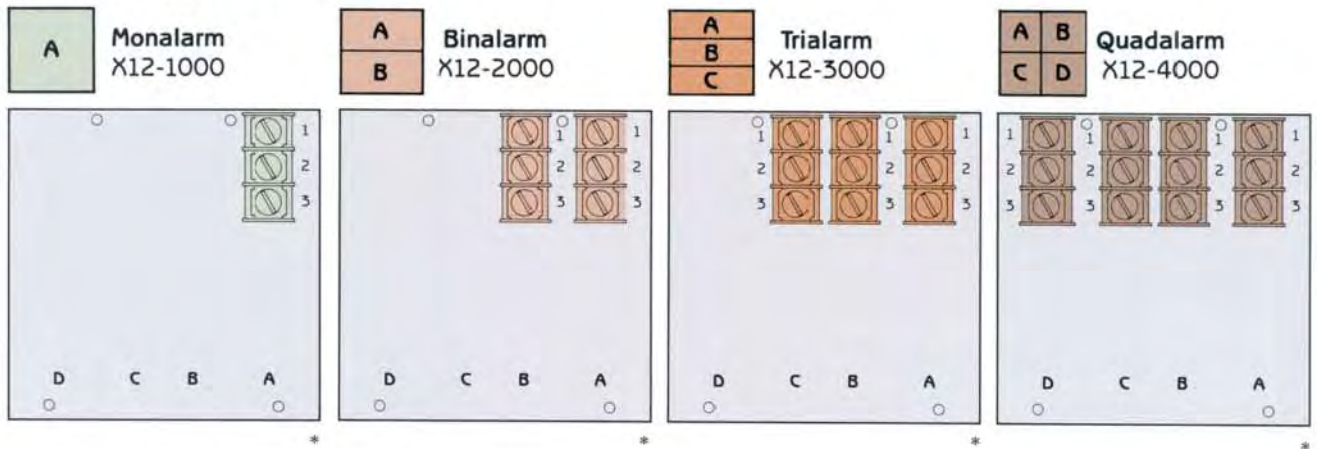

Standard and First Out Sequences with Auxiliary Contact Output

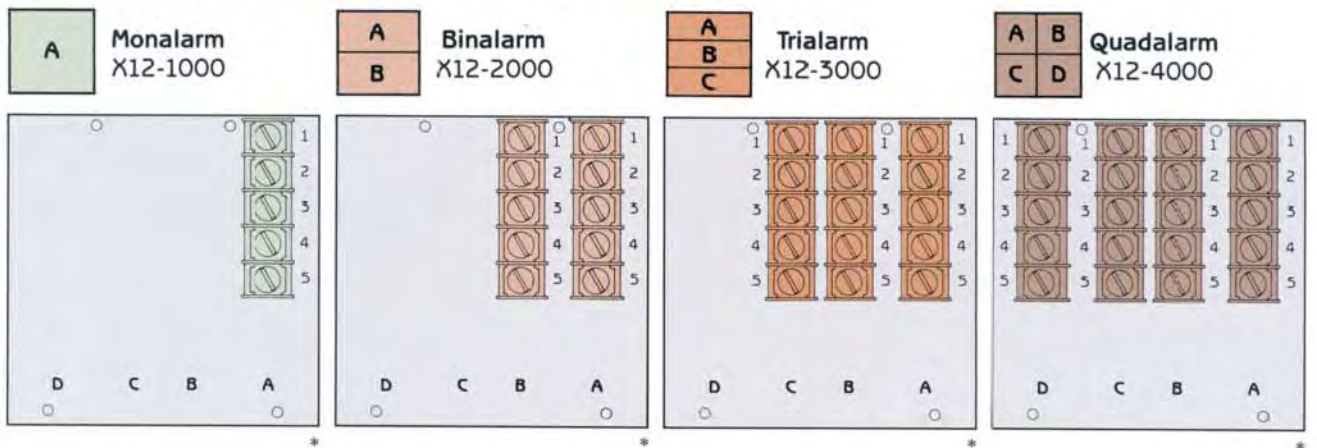

Standard and First Out Sequences with Auxiliary Contact Output and Analog Input

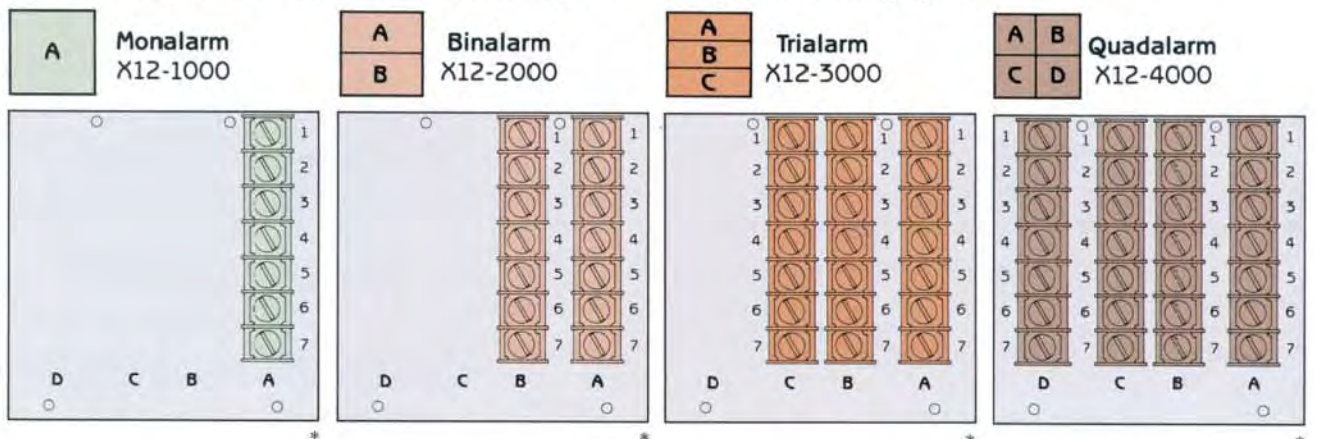

*B, C and D positions may be available for Auxiliary Function Modules if not used for Sequence Modules on Monalarm, Binalarm or Trialarm.

SPECIAL MOUNTING

Type I – Wall Mounting

Surface mounted on plate in Nema 4 or Nema 12 enclosure. Also available in fiberglass enclosure.

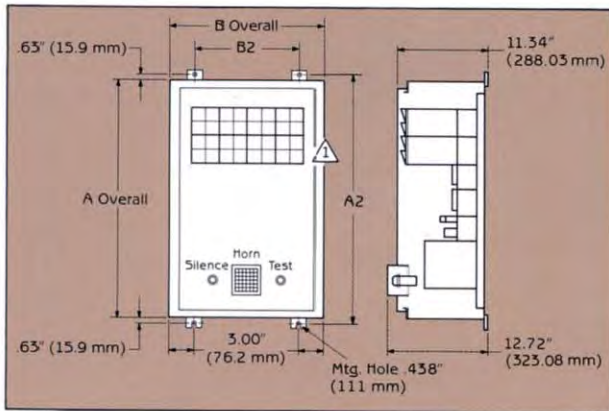

Type II – Wall Mounting

Surface mounted on plate (no enclosure).

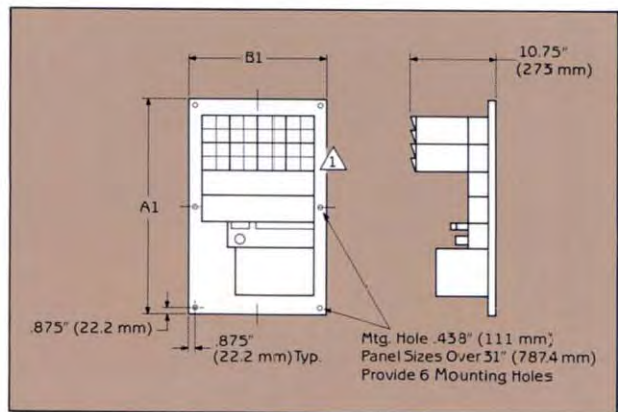
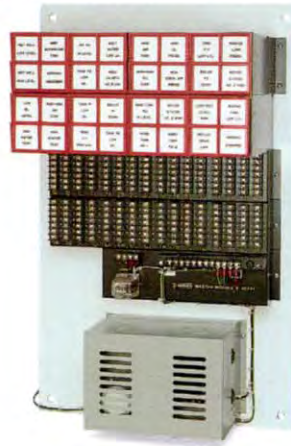

Enclosure and Plate Dimensions

NEMA Enclosure						X125M-1000 Monalarm ¹		X125M-2000 Binalarm ²		X125M-3000 Trialarm ³		X125M-4000 Quadalarm ⁴	
A Overall Dimensions		B Overall Dimensions		A1 Panel Dimensions		B1 Panel Dimensions		A2 Dimensions		B2 Dimensions		Maximum Number of Windows	
In.	mm	In.	mm	In.	mm	In.	mm	In.	mm	In.	mm	High	Wide
24.00	609.6	20.00	508.0	21.00	533.4	17.00	431.8	25.25	641.4	14.0	355.6	1	4
24.00	609.6	24.00	609.6	21.00	533.4	21.00	533.4	25.25	641.4	18.0	457.2	1	5
30.00	762.0	20.00	508.0	27.00	685.8	17.00	431.8	31.25	793.8	14.0	355.6	2	4
30.00	762.0	24.00	609.6	27.00	685.8	21.00	533.4	31.25	793.8	18.0	457.2	2	5
36.00	914.4	24.00	609.6	33.00	838.2	21.00	533.4	37.25	946.2	18.0	457.2	3	5
36.00	914.4	30.00	762.0	33.00	838.2	27.00	685.8	37.25	946.2	24.0	609.6	3	7
42.00	1066.8	30.00	762.0	39.00	990.6	27.00	685.8	43.25	1098.6	24.0	609.6	4	7
42.00	1066.8	36.00	914.4	39.00	990.6	33.00	838.2	43.25	1098.6	30.0	762.0	4	9
48.00	1219.2	30.00	762.0	45.00	1143.0	27.00	685.8	49.25	1251.0	24.0	609.6	5	7
48.00	1219.2	36.00	914.4	45.00	1143.0	33.00	838.2	49.25	1251.0	30.0	762.0	5	9
60.00	1524.0	36.00	914.4	57.00	1447.8	33.00	838.2	61.25	1555.8	30.0	762.0	7	9

¹Nameplate Size: 2.75" (69.9 mm) H x 3.00" (76.2 mm) W
²Nameplate Size: 1.4" (35.6 mm) H x 3.00" (76.2 mm) W
³Nameplate Size: .86" (21.8 mm) H x 3.00" (76.2 mm) W
⁴Nameplate Size: 1.4" (35.6 mm) H x 1.4" (35.6 mm) W

⚠ Last "D" alarm position not available; reserved for Flasher/Horn Driver Module.

Notes: Larger units available on special order. Enclosure depth: 10" (254.0 mm).

Surface Mount Annunciator must be mounted on a mounting plate as a Type I or Type II only.

Type III – Door Mounting

Mounted in the door of an enclosure. Recommended for sizes up to 4 high x 5 wide systems only.

- A. To establish proper enclosure size required add two cabinet modules to annunciator system width (for door swing clearance).
- B. Enclosure depth: 16 inches.

TERMINAL ARRANGEMENTS

Wall/Surface Mount Monalarm X125M-1000

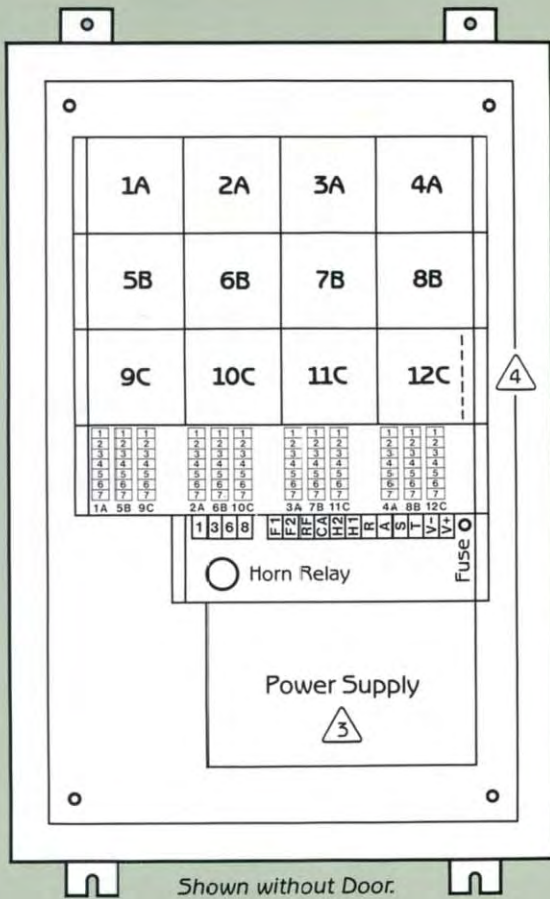

Detail of Terminal Arrangement*

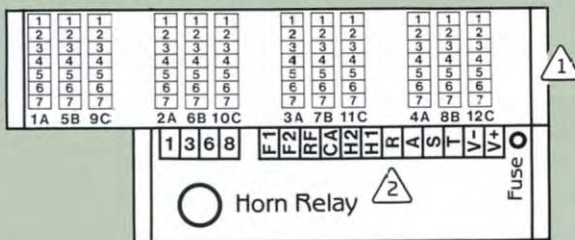

Wall/Surface Mount Binalarm X125M-2000

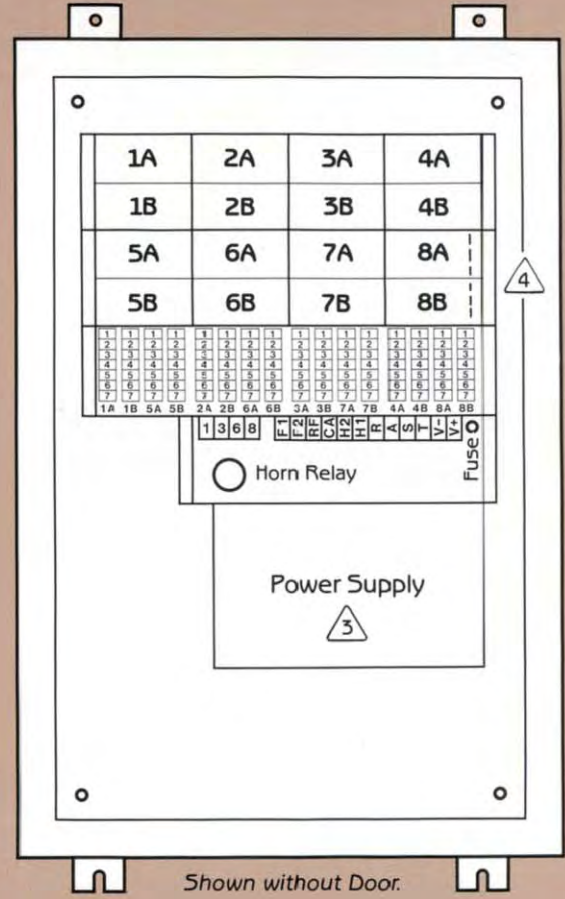

Detail of Terminal Arrangement*

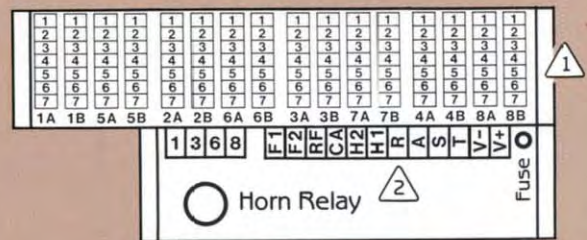

Notes:

- ① Each Alarm Point Supplied with 3, 5 or 7 Terminals Dependent on Alarm Sequence and/or Auxiliary Functions Supplied
- ② For Systems Support Wiring Refer to Page 24

- ③ For Power Supplies Sizing See Page 19
- ④ Flasher/Horn Driver Located in the "D" Alarm Module Position. Horns and Pushbuttons Mounted on the Front Door and Supplied Prewired.

*Terminal arrangements shown are typical and may vary depending on number of alarms and terminals required.

TERMINAL ARRANGEMENTS

Wall/Surface Mount Trialarm X125M-3000

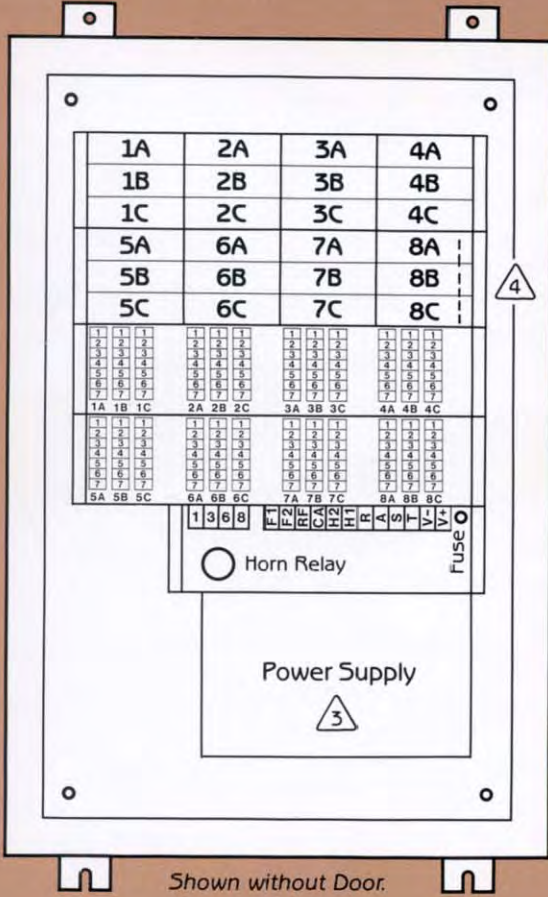

Shown without Door.

Wall/Surface Mount Quadalarm X125M-4000

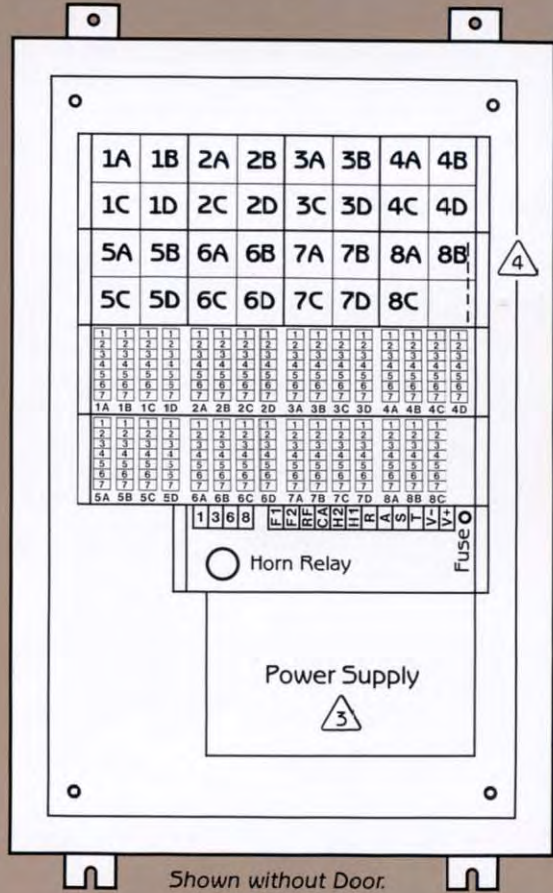

Shown without Door.

Detail of Terminal Arrangement*

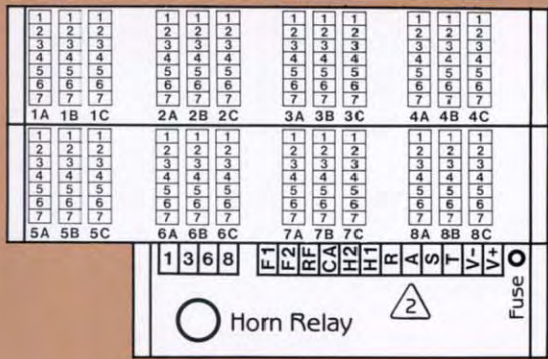

Detail of Terminal Arrangement*

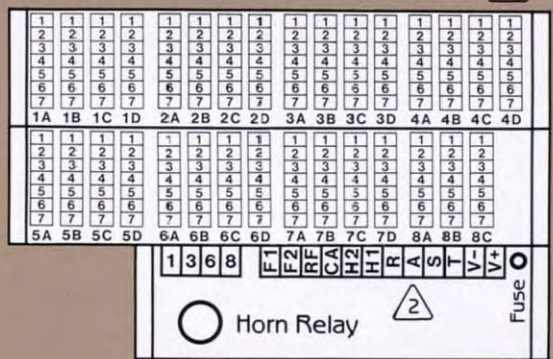

Notes:

1 Each Alarm Point Supplied with 3, 5 or 7 Terminals
Dependent on Alarm Sequence and/or Auxiliary Functions
Supplied

2 For Systems Support Wiring Refer to Page 24

3 For Power Supplies Sizing See Page 19

4 Flasher/Horn Driver Located in the "D" Alarm Module Position.
Horns and Pushbuttons Mounted on the Front Door and
Supplied Prewired.

*Terminal arrangements shown are typical and may vary depending on number of alarms and terminals required.

SYSTEMS SUPPORT

Flasher Module

The dual frequency flashing signal generator and the pushbutton/audible alarm interface is furnished by the flasher module. The flasher is master/slave selectable to allow synchronization of flash rates in multi-system applications. The module is designed to drive up to 150 points of alarm and for convenience purposes is always located behind the lower right hand module of the system.



Master Terminals

The remote pushbuttons, audible alarm and power wiring are terminated at the Master Terminal



Assembly located on the rear of the system's chassis. Polarity protection, for reverse power hook-up, and a system's fuse, are an integral part of the Master Terminal Assembly.

Filter Module

All remotely located pushbuttons and DC power input lines are fed to the system via integral filter modules, servicing up to 50 alarm points (36 points for 1000 Series). For larger systems, use additional RF-24-2 Filter Modules.

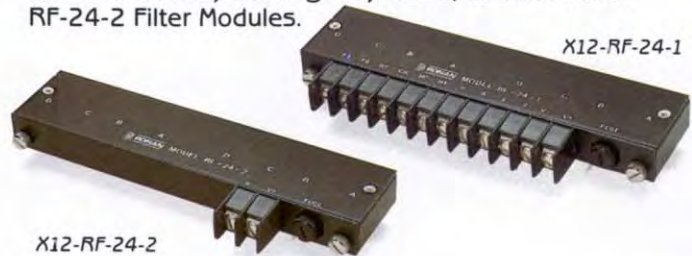

Systems Support Wiring

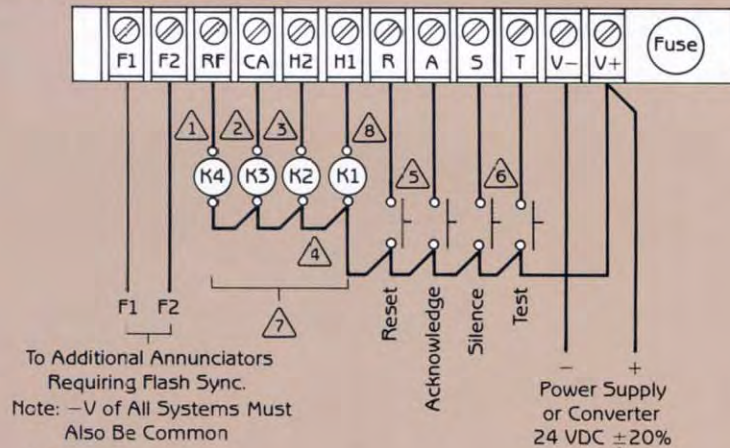

Notes:

- 1 K4 Only Used on Systems with Modified Reflash Capability
- 2 K3 Only Used on Systems Equipped with Common Alarm Output
- 3 K2 Only Used for Dual Horn or Ringback Systems
- 4 K1 and K2 Are Not Required if Ronan X36 Electronic Horns Are Utilized. X36 Horns May Be Direct Connected with Red Wire to +V and Blue Wire to H1 or H2 Respectively.
- 5 Reset Pushbutton Utilized for Manual Reset, Ringback or First Out Reset Sequences Only

- 6 Silence Pushbutton Utilized for Horn Silence Sequences Only
- 7 All Relay Coils Must Be 24 VDC, 250 mA (Max.) SPDT or DPDT Contacts as Required. Standard Relay KRP24DC for GP and KR7272 for Hermetically Sealed.
- 8 Horn Relay K1 Internally Wired on Surface Mount Models as Follows:



125 VDC or 48 VDC Field Contact Applications

The lower left alarm module position, terminal row D, is utilized for applications with 125 VDC field contact sensing voltage. Module to module connections are internally provided. (Other optional field contact sensing voltages such as 48 VDC are available).

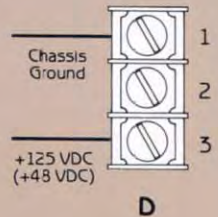

Alarm Sequence Modules

Standard and First Out Sequence

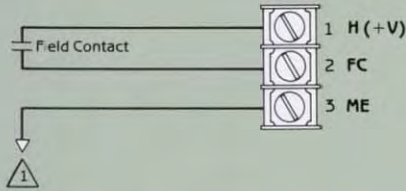

Standard and First Out Sequence

With Thermocouple Input and Auxiliary Contact Output

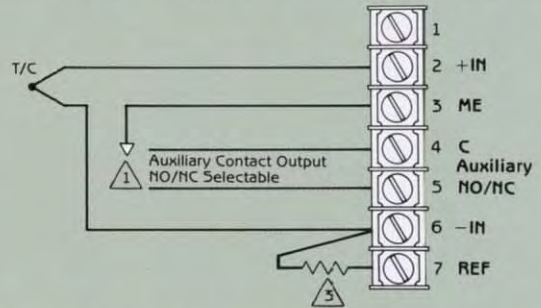

Standard and First Out Sequence

With Auxiliary Contact Output

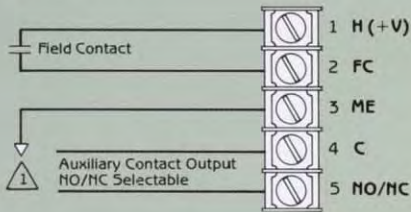

Standard and First Out Sequence

With RTD Input and Auxiliary Contact Outputs

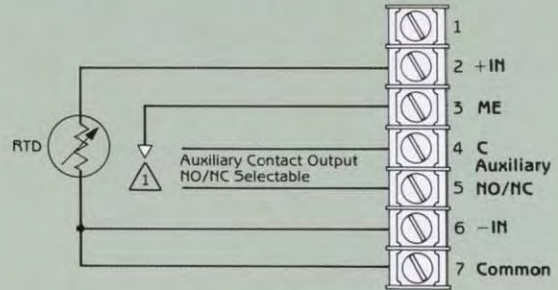

Standard and First Out Sequence

With Analog Input and Auxiliary Contact Output

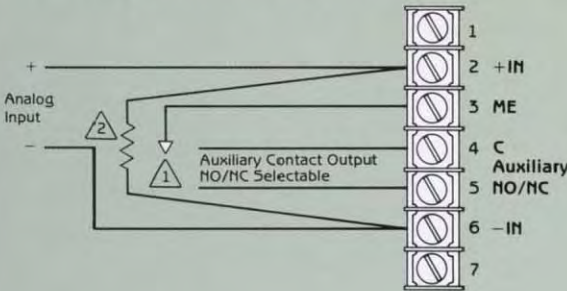

Standard and First Out Sequence

With Dual Auxiliary Outputs

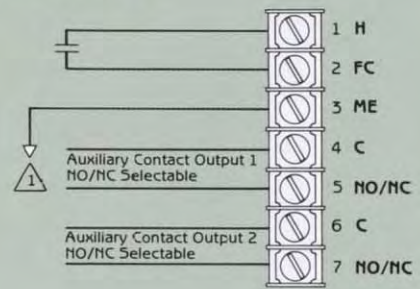

Standard and First Out Sequences

With Transistor Input Negative Logic
(Use Open Collector Input Modules)

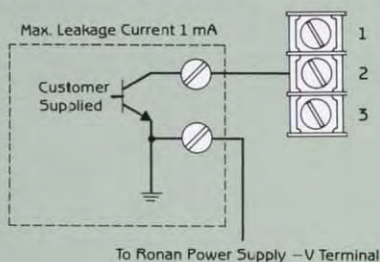

Standard and First Out Sequences

With Transistor Input Positive Logic
(Use Standard 24 VDC Input Modules)

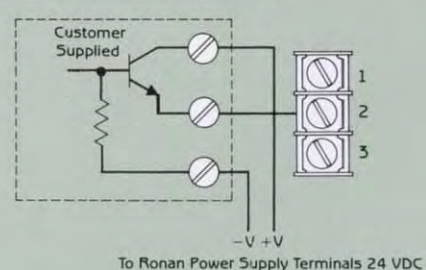

WIRING/AUXILIARY FUNCTIONS

Auxiliary Function Modules without Integral Alarm Sequence

Trip Module mV, mA — X50 Series
Analog Input — Auxiliary Contact Output

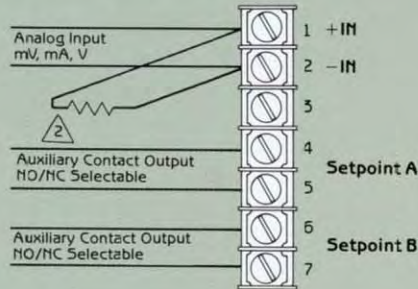

Tri Auxiliary Contact Module — X1216TC-3
With System Internal Field Contact Connections

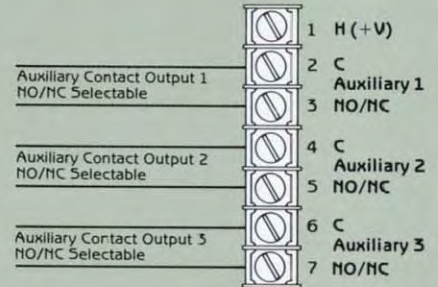

Trip Module — X50T Series
T/C Input — Auxiliary Contact Output

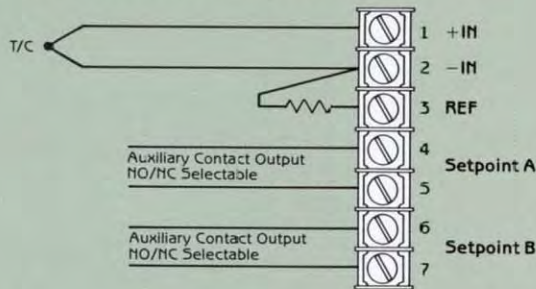

Reflash Module — RFL-4

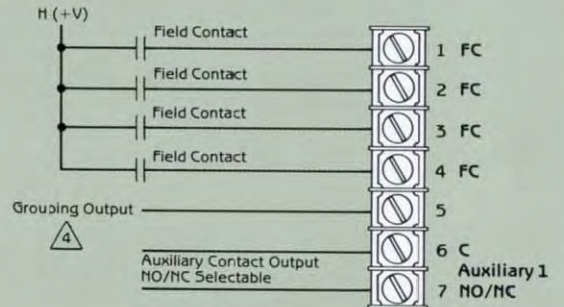

Trip Module X50R Series
RTD Input — Auxiliary Contact Output

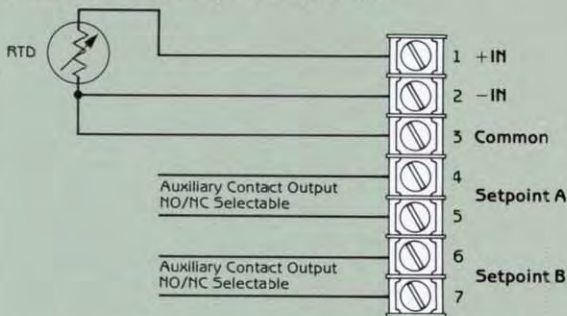

Motion Detector Module — SS 2137

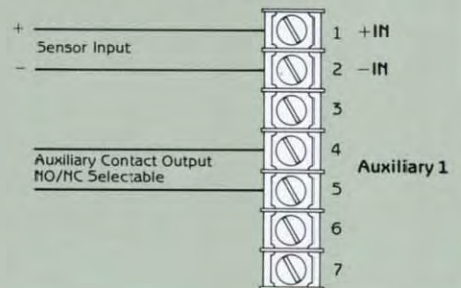

Dual Auxiliary Contact Module — X1216TC-2
With External Field Contact Connections

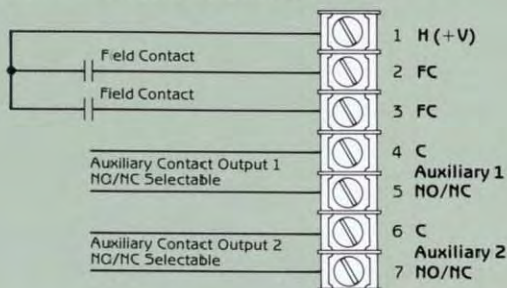

Notes:

Used with First Alert Alarm Sequences

- ⚠ Connect to All ME Terminals of Points Desired in a First Alert Group
- ⚡ Resistor Factory Installed for Current Loop Input Only
- ⚡ Cold Junction Compensation Resistor for T/C Input Only (Factory Installed)
- ⚡ Connect Grouping Terminals of RFL Modules Desired in the Same Group (Expands Groups in Increments of 4 Inputs).

- REF Thermocouple Reference Junction Input
- +IN Plus Analog Voltage
- IN Minus Analog Voltage
- Common Common Return
- H +24 VDC
- FC Field Contact Return
- ME First Out Grouping Terminal
- C Common of Auxiliary Contact
- NO/NC Normal Open/Normal Closed Contact

ACCESSORIES — PUSHBUTTONS/HORNS

Pushbuttons

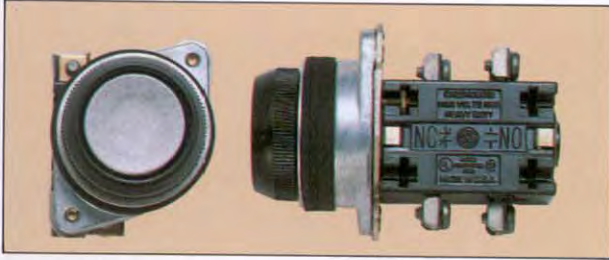

General Purpose

Type	Contact	Rating
202B Oil Tight	1NO 1NC	
203B Pushbutton	2 NO 2NC	24VDC, 5 Amp.
2025 Oil Tight	1NO 1NC	125VDC, 2 Amp.
2035 Switch	2NO 2NC	

Mercury Type — Class I Div. 2 Locations

Type	Contact	Rating
X13P () () P.B.	Up to	24VDC, 10 Amp.
X135 () () Switch	4NO or NC	125VDC, 5 Amp.

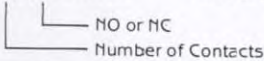

Horn Relays

General Purpose

Model	Voltage	Contact Rating
KRP-24VDC	24VDC	10 Amp.

Hermetically Sealed — Class I Div. 2

Model	Voltage	Contact Rating
KR7272	24VDC	10 Amp.



Socket

Model 146-103 to be mounted by customer.

Power Supplies

(For Details see Page 19)

Water Tight Doors

- () () X12-1022N12, Nema 12
- () () X12-1022N4, Nema 4

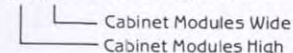

Horns — Vibrating Type

Model	Description
350N-115 VAC	Class I, Division 2 or General Purpose
450N-(Voltage)	General Purpose — Specify 125VDC or 24VDC
350W-115 VAC	Class I, Division 2 or General Purpose
450W-(Voltage)	General Purpose — Specify 125VDC or 25VDC
350F-115 VAC	Class I, Division 2 or General Purpose
450F-(Voltage)	General Purpose — Specify 125VDC or 24VDC
351N-115 VAC	Class I, Division 2 or General Purpose
451N-(Voltage)	General Purpose — Specify 125VDC or 24VDC
351W-115 VAC	Class I, Division 2 or General Purpose
451W-(Voltage)	General Purpose — Specify 125VDC or 24VDC
8140-115 VAC	Explosion Proof Class I, Division 1
8141-(Voltage)	Explosion Proof Class I, Division 1, 125VDC or 24VDC
300XB-(Voltage)	Explosion Proof Class I, Division 1, 24VAC, 125VDC or 24VDC
8130-115 VAC	Explosion Proof Class I, Division 1
8131-24VDC	Explosion Proof Class I, Division 1

*Choose voltage from description column.



Bells

Model	Description
504N-115 VAC	General Purpose, 4 Inch Diameter
506N-115 VAC	General Purpose, 6 Inch Diameter
510N-115 VAC	General Purpose, 10 Inch Diameter
604N-125 VDC	General Purpose, 4 Inch Diameter
606N-125VDC	General Purpose, 6 Inch Diameter
610N-125VDC	General Purpose, 10 Inch Diameter
504W-115 VAC	Weatherproof, 4 Inch Diameter
506W-115 VAC	Weatherproof, 6 Inch Diameter
510W-115 VAC	Weatherproof, 10 Inch Diameter
604W-125VDC	Weatherproof, 4 Inch Diameter
606W-125VDC	Weatherproof, 6 Inch Diameter
610W-125VDC	Weatherproof, 10 Inch Diameter



Chimes — Single Stroke

- X12-1128-115VAC
- X12-1128-125VDC
- X12-1128-24VDC



Horns — Electronic

- X36-24VDC
- X36-48VDC
- X36-115VAC
- Sonalert-24VDC
- Sonalert-115VAC

ORDERING INFORMATION

Ronan Sequence Logic Module Selection

Note: Additional options (not shown) available. Not all options available on all sequences. Please contact factory to discuss your specific requirements.

Ronan ID	Description	ISA
AS	Automatic Reset	A
AM	Manual Reset	M
AH	Audible Silence	A-1
AMH	Manual Reset/Audible Silence	M-1
ASL	No Flash/No Audible (Status)	A-4-5-6
AMC	Red — Alarm; Green — Return-to-Normal	
F5	First Out-Fast Flash/Subsequent Steady ON/Automatic Reset	F2A
FSM	First Out-Fast Flash/Subsequent Steady ON/Manual Reset	F2M
FSH	F5 with Audible Silence	F2A-1
FSMH	F5 with Audible Silence/Manual Reset	F2M-1
F3A	First Out/Ack. Intermittent Sub. Slow	F3A-3
FD	First Out-Fast Flash/Sub. Slow Flash	*
FD/AS	Selectable	
FDH/AH	Selectable with Audible Silence	
FDH	FD with Audible Silence	
FDHI	FD with Audible Silence/Alarm Inhibit	
FRDK	First Out/Ringback/Dual Audible	
FRDH	First Out/Ringback/Intermittent Flash	F3R-1-3
FDRW	Red-First/White-Subsequent/Ringback	
RD	Ringback	R
RDSH	Ringback with Audible Silence/Interlock	R-1-2
RDK	Ringback with Dual Audible	
RACD	Automatic Ringback Flash	
SUPR	Supervised Field Contact Wiring	
AND	Multiple AND Gates	
OR	Multiple OR Gates	
INV	Multiple Inverter Gates	
DEL	Multiple Time Delays	
OS	Multiple One-Shots	
FF	Multiple Flip-Flops	
MD	Motion Detector	

Code	Special Options
00	None
26	Time Delay 0-.5 sec.
01	Time Delay 1-45 sec.
17	Time Delay 1-30 sec.
02	Time Delay 2.5-90 sec.
03	Time Delay 5 sec.-3 min.
04	Time Delay .1-6 min.
18	Time Delay 6 sec.-15 min.
13	Time Delay 12 sec.-30 min.
05	Time Delay .5 sec.
23	Time Delay 1 sec. Fixed
11	Time Delay 60 sec. Fixed
14	Time Delay 1-45 sec. and Dual Horn
22	Time Delay 1-45 sec., Lamp Dim
21	Time Delay .5 sec., Lamp Test Only
25	Time Delay 1-30 sec., Operation from 125 VDC Power Source
06	Lamp Test Only
07	Short Circuit-Proof Lamp Driver
08	CTA/Follow F/C
09	ISA Option 1, 2, 3
10	Lamp Dim
12	Dual Setpoint (Analog)
15	Dual Color, Two Wire
16	Individual Audible Output per Window
19	Dual Audible
20	Short Circuit-Proof Lamp Driver, Dual Audible
24	Operation from 125 VDC Power Source
27	Individual Audible per Window, Lamp Test Only
28	No Audible

* Similar to F3A-3 (No Intermittent)

- 0 0 0 0

Code	Input
0	24 VDC FC Voltage
P	48 VDC FC Voltage
1	125 VDC FC Voltage
2	125 VDC FC (Live 40-140 DC)
6	Open Collector
7	24 VDC Opto-Coupled (10-30 VDC)
X	115 VAC FC, Triac Input - 3 mA Leakage
N	0-1 mA
4	4-20 A
M	10-50 mA
F	0-10 mV
G	0-25 mV
H	0-50 mV
L	0-5 V
5	1-5 VDC
9	9 Ohms RTD
A	10 Ohms RTD
B	100 Ohms RTD
C	120 Ohms RTD
D,E,J,K, R,S,T	T/C Types
8	FC Wiring Monitored

Code	Output
0	Standard
1	Aux. Contact GP, NE, FC Follower
2	Aux. Contact GP, NDE, FC Follower
3	Aux. Contact GP, NE, Lamp Follower
4	Aux. Contact GP, NDE, Lamp Follower
5	Aux. Contact HS, NE, FC Follower
6	Aux. Contact HS, NDE, FC Follower
7	Aux. Contact HS, NE, Lamp Follower
8	Aux. Contact HS, NDE, Lamp Follower
K	Aux. Contact GP, NDE, Follows Acknowledge
D	Dual Aux. Contact GP, NDE, FC Follower
E	Dual Aux. Contact HS, NDE, FC Follower
N	Dual Aux. Contact HS, NE, FC Follower
M	Dual Aux. Contact HS, NDE, Lamp Follower
A	Common Trouble Alarm, FC Follower
F	Common Trouble Alarm, Lamp Follower
G	Aux. Contact GP, NDE and CTA, Lamp Follower
H	Aux. Contact GP, NDE, FC Follower, Relay Test Only
L	Aux. Contact GP, NDE, and Individual Aux. Audible
9	Dual Audible, Selectable
J	Dual Audible, Aux. Relay GP, NE, FC Follower
B	Positive Logic (AND, OR, INV. Logic Cards)
C	Dual Color, One Wire

NE Normally Energized Aux. Auxiliary — Typically a Repeater
 NDE Normally De-Energized Contact Integral on Alarm Module
 FC Field Contact GP General Purpose
 CTA Common Trouble Alarm HS Hermetically Sealed

ORDERING INFORMATION

Support Modules

Flasher/Horn Driver Module

FHD24 - () - () - ()

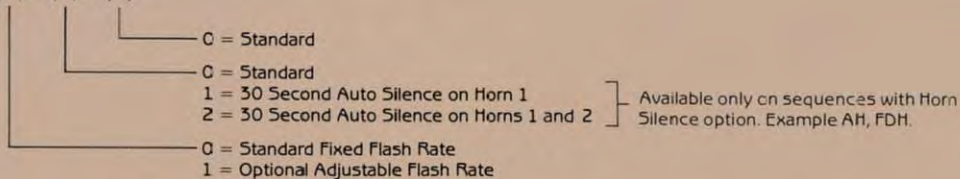

1. Module drives up to 150 points.
2. Module occupies one position in lower right hand cabinet module.
3. Master/Slave selectable to synchronize flash rate in multiple chassis or module application.
4. Automatic Silence, Acknowledge and Reset on power up.
5. Horn Driver sized to drive KRP-24VDC Relay or X36 Electronic Horn.

Filter Module

RF-24-1: Main Filter Module. Power capacity — 10 Amp. Use additional filters (RF-24-2) for systems larger than 50 alarm points (36 points for 1000 Series).

RF-24-2: Additional Filter Modules. Power capacity — 10 Amp.

Auxiliary Function Modules

Analog Trip Modules

- Thermocouple

- X50T-(E) - () - () Type E, Single Channel, Single Setpoint
- X50T-(J) - () - () Type J, Single Channel, Single Setpoint
- X50T-(K) - () - () Type K, Single Channel, Single Setpoint
- X50T-(T) - () - () Type T, Single Channel, Single Setpoint
- X50T-(DE) - () - () Type E, Single Channel, Dual Setpoint
- X50T-(DJ) - () - () Type J, Single Channel, Dual Setpoint
- X50T-(DK) - () - () Type K, Single Channel, Dual Setpoint
- X50T-(DT) - () - () Type T, Single Channel, Dual Setpoint

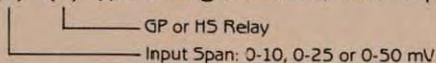

- RTD — Resistance Temperature Devices

- X50R - () - () - () Single Channel, Single Setpoint
- X50DR - () - () - () Single Channel, Dual Setpoint

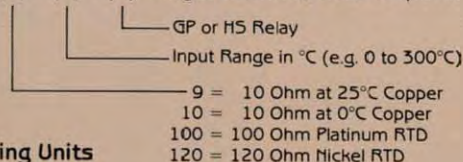

- Engineering Units

- X50S - () - () Single Channel, Single Setpoint with Adjustable Hysteresis
- X50SS - () - () Dual Channel, Single Setpoint with Adjustable Hysteresis
- X50D - () - () Single Channel, Dual Setpoint with Adjustable Hysteresis

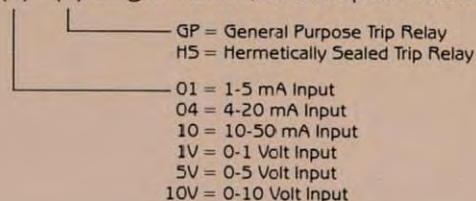

ORDERING INFORMATION

Reflash Modules

- RFL4- () - () 4 Input Reflash Module, Contact Output
- RFL4- () - () - (1) 4 Input Reflash Module with Contact and Transistor Switch Output
- RFL4- () - () - (2) 4 Input Reflash Module with Contact Output, Manual Reset Output
- RFL4- () - () - (3) 4 Input Reflash Module with Contact Output, Open Collector Input

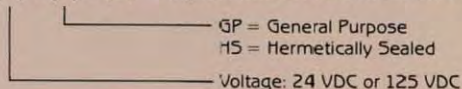

Auxiliary Contact Modules

- X1216TC-1GP 1 Output Contact, General Purpose
- X1216TC-2GP 2 Output Contacts, General Purpose
- X1216TC-3GP 3 Output Contacts, General Purpose
- X1216TC-4GP 4 Output Contacts, General Purpose
- X1216TC-1HS 1 Output Contact, Hermetically Sealed
- X1216TC-2HS 2 Output Contacts, Hermetically Sealed
- X1216TC-3HS 3 Output Contacts, Hermetically Sealed
- X1216TC-4HS 4 Output Contacts, Hermetically Sealed

Ground Fault Detector Module

- GD - () - () - 1 P.C. Board Type Ground Detector

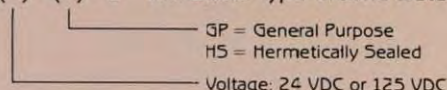

Motion Detector Modules

- SS2137-GP Loss of Motion Detection Module with Adjustable Time Delay and Sensitivity, GP Relay Contact Output
- SS2137-HS Same as above with HS Relay

Special System Requirements

Hazardous Areas

The Ronan Series X12 Alarm Systems are available with UL or CSA approval for use in Class I, Division 2, Groups A, B, C, D hazardous area classifications. These systems do not require purging for use in these areas. Contact the factory for assistance in specifying these systems.

Intrinsically Safe Systems

Ronan has a complete line of intrinsically safe X57 Barriers which may be integrated into X12 Systems. Contact the factory for assistance specifying these systems.

High Temperature Systems – X12-HT

A special Series X12 Alarm System is available for applications in extremely hot environments. Thorough testing and years of extended service in desert and oil field environments have shown that these systems operate reliably in ambient temperatures of up to 185°F (85°C). The X12HT Series features teflon insulated wiring, hermetically sealed ceramic integrated circuits, special high temperature electronic components, gold plated printed circuit board connectors and anti-fungus coating on all P.C. boards. High temperature hermetically sealed Military Specification type relays with operating ambient temperature range of up to 257°F (125°C) are utilized. All model numbers need HT identifier to assure compliance with the high temperature requirement.

TYPICAL ORDERING INFORMATION

X12 Series Window Model

QTY

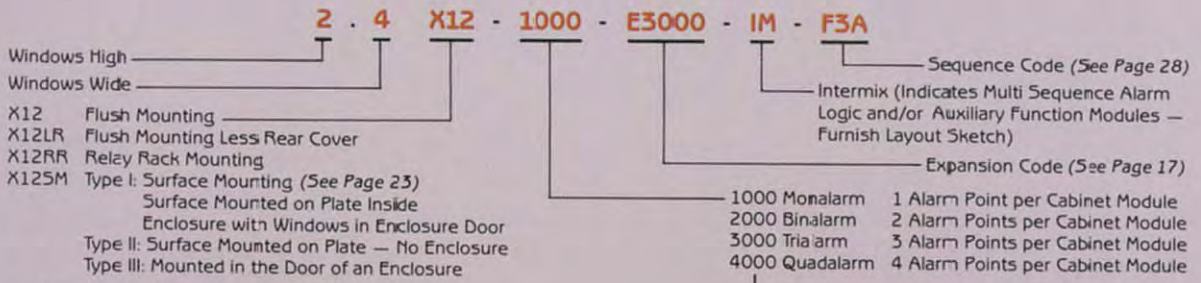

System Details

- () () X125M-() Cabinet Modules (See Page 23)
- () () Nema (4 or 12) Enclosure (Specify Accessories Mounted Integral) (See Page 27)
- LM ()-24 Lamp Module (1-4 Alarm Points per Module) (See Page 16)
- LM ()-24-(Color) LED Lamp Module (1-4 Points per Module). Specify Color: Red, Green or Amber

Support Modules

- FHD24-()-()-() Flasher/Horn Driver Module (Order One per 150 Points) (See Page 29)
- RF-24-1 Filter Module (Order One per 50 Points, One per 36 Points 1000 Series)
- RF-24-2 Additional Filter Module (Order One per 50 Points, One per 36 Points 1000 Series)

Alarm Modules

- Alarm Sequence Module (See Pages 14, 15 and 28)

Auxiliary Function Modules

- X50 — ()-()-() Analog Trip Module (See Page 29)
- RFL4-()-()-() Reflash Module (See Page 30)
- X1216TC-() Auxiliary Contact Module (See Page 30)
- GD-()-()-1 Ground Fault Detector Module (See Page 30)
- SS2157-() Motion Detector (See Page 30)

Accessories

- X12P () Integral Pushbutton (One Station per Cabinet)
 2, 3A, 3B or 4 (Test, Silence, Acknowledge, Reset) (See Page 16)
- 202B Pushbutton — External or Nema Enclosure Mounted — General Purpose (See Page 27)
- X13P1NO Pushbutton — External or Nema Enclosure Mounted — Class I, Division 2 (See Page 27)
- KRP-24 Horn Relay — General Purpose Type (See Page 27)
- KR-7272 Horn Relay — Class I, Division 2 (See Page 27)
- 146-103 Socket for Horn Relay (See Page 27)
- Horns (See Page 27)
- Bells (See Page 27)
- Chimes (See Page 27)
- Power Supply/Inverter (Order as Required) (See Page 19)
- Enclosure — Specify Size and Type (See Page 21)
- Watertight Door — Specify Size and Type (See Page 27)

Options

- Gold Plated Printed Circuit Connectors
- Fungus-Proof Coating
- Sandwich Lenses (Specify Colors)
- Color Lenses (Specify Colors)
- Ground Fault Isolation Switch
- System Air Purge
- Intrinsically Safe Inputs (FM Approved) (See Page 30; Also See Catalog IS-Systems)
- Special High Temperature System (185°F/85°C) (See Page 30)
- Electrical Classification — Cl. I, Div. 2, Gr. A, B, C, D



RONAN ENGINEERING CO.
 21200 Oxnard Street
 Woodland Hills, CA 91367
 (800) 327-6626
 FAX (818) 992-6435
 E-Mail: info@ronan.com
 Web: www.ronan.com

RONAN ENGINEERING LTD. U.K.
 1 Tilley Road
 Crowther Industrial Estate
 Washington, Tyne and Wear
 United Kingdom, NE38 OAE
 (191) 416-1689
 FAX (191) 416-5856

RONAN ENGINEERING LTD.
 32 Bermondsey Road
 Toronto, Ontario
 Canada M4B 1Z5
 (416) 752-0310
 FAX (416) 752-8072